



12-2007

Effects of Environmental Stress on Growth, Yield, and Flavonolignan Content in Milk Thistle *Silybum marianum* L. Gaertn

Amy Renae Belitz
University of Tennessee - Knoxville

Follow this and additional works at: https://trace.tennessee.edu/utk_gradthes



Part of the [Environmental Sciences Commons](#)

Recommended Citation

Belitz, Amy Renae, "Effects of Environmental Stress on Growth, Yield, and Flavonolignan Content in Milk Thistle *Silybum marianum* L. Gaertn. " Master's Thesis, University of Tennessee, 2007.
https://trace.tennessee.edu/utk_gradthes/115

This Thesis is brought to you for free and open access by the Graduate School at TRACE: Tennessee Research and Creative Exchange. It has been accepted for inclusion in Masters Theses by an authorized administrator of TRACE: Tennessee Research and Creative Exchange. For more information, please contact trace@utk.edu.

To the Graduate Council:

I am submitting herewith a thesis written by Amy Renae Belitz entitled "Effects of Environmental Stress on Growth, Yield, and Flavonolignan Content in Milk Thistle *Silybum marianum* L. Gaertn." I have examined the final electronic copy of this thesis for form and content and recommend that it be accepted in partial fulfillment of the requirements for the degree of Master of Science, with a major in Plant Sciences.

Carl E. Sams, Major Professor

We have read this thesis and recommend its acceptance:

Dean A. Kopsell, Svetlana Zivanovic

Accepted for the Council:

Carolyn R. Hodges

Vice Provost and Dean of the Graduate School

(Original signatures are on file with official student records.)

To the Graduate Council:

I am submitting herewith a thesis written by Amy Renae Belitz entitled “Effects of environmental stress on growth, yield, and flavonolignan content in milk thistle (*Silybum marianum* L. Gaertn.)” I have examined the final electronic copy of this thesis for form and content and recommend that it be accepted in partial fulfillment of the requirements for the degree of Master of Science, with a major in Plant Sciences.

Carl E. Sams, Major Professor

We have read this thesis
and recommend its acceptance:

Dean A. Kopsell

Svetlana Zivanovic

Accepted for the Council:

Carolyn R.Hodges
Vice Provost and Dean of the Graduate School

(Original signatures are on file with official student records.)

Effects of environmental stress on growth, yield, and flavonolignan content in milk thistle
(*Silybum marianum* L. Gaertn)

A Thesis
Presented for the
Masters of Science Degree
The University of Tennessee, Knoxville

Amy Renae Belitz
December 2007

Dedication

I would like to dedicate this thesis to my parents, Larry and Celia Belitz. Their faith in and support of me has been constant during times when all seemed impossible.

Acknowledgements

I would like to thank all the people that have helped me complete this project. I thank my major professor, Dr. Carl Sams, for providing me an opportunity to study a medicinal plant and develop skills that will benefit me throughout my life. I thank my committee members, Dr. Dean Kopsell and Dr. Lana Zivanovic for their input and encouragement. I would like to thank Dr. Craig Charron who, during his time at UTK and even after his departure, has been an enormous help in figuring out all the lab problems, large and small. His guidance has been invaluable in learning the nuances of HPLC. Many thanks to Dr. Bill Klingeman who allowed me to use his greenhouse when I found myself with no home for my water experiment. Also, thank you to the University of Belgrade who supplied me with milk thistle seeds from Serbia.

Finally I wish to thank all of my family, my friends, my co-workers, and all the people that have come through the lab and helped me on greenhouse and lab projects, especially Christina Larson, Catherine Nyinyi, Tiffany Fly, Jonathan Mixon, Teena Hayden, and Casey Barickman. Many times this has been a group effort, and I could not have finished this without your help.

Abstract

Four experiments were performed in a greenhouse or growth chamber to study the quantity and quality of flavonolignans in response to environmental stress in milk thistle (*Silybum marianum* L., Gaertn.). A preliminary experiment was conducted in spring 2004 to study effects of leaf harvests on growth, development, and flavonolignan content in milk thistle seeds. Taxifolin, a component of silymarin and precursor to flavonolignans, was significantly reduced due to leaf harvest treatments.

The weedy nature (sporadic germination) of *Silybum* made germinating enough plants for experimentation problematic. Initial germination studies to determine imbibition and pre-chilling requirements were inconclusive due to heavy fungal infections. A sterilization procedure was chosen to treat seeds before experimental use and flavonolignan analysis. Germination trials were also performed with seven other seed sources. Seeds harvested in Croatia showed the best germination and were used for subsequent experiments.

Flavonolignans in *Silybum* seeds are reported to vary depending on environmental conditions and genetic diversity within a population. In another experiment, total silymarin concentrations determined from eight seed sources from around the world ranged from 29.6 to 56.9 mg/gram of seed meal. Individual flavonolignans varied significantly in and among seed sources.

In the first stress experiment was, plants were grown in pine bark media in polyethylene bags. Plant densities from 1-24 plants/bag were established. Immature and

total seed counts and yields decreased with increasing density. Number of blooms per plant, bloom diameter, and mature seed count and yield were negatively correlated to density. There was no significant effect of plant density on flavonolignan content.

In the second stress experiment, milk thistle plants were grown in perlite in polyethylene bags. Water treatments (200, 650, 1100, 1550, and 2000 mL/day including fertigation) were created using pressure-compensated emitters. The lowest watering rate significantly reduced stem height and bloom diameter. The highest water treatment showed the highest count of immature seeds. In primary blooms, the lowest water rate yielded the highest taxifolin concentration (0.89 mg/g). Flavonolignan content was not significantly affected in secondary blooms.

Silybum growth and development was affected by environmental stress. However, no significant effect on silymarin concentration or composition was established.

Table of Contents

<i>Chapter</i>	<i>Page</i>
I. Introduction	1
II. Literature Review	3
Overview of secondary metabolites.....	3
Medicinal Plants (general).....	4
Modern Opinion.....	6
<i>Silybum</i> – Taxonomy & Culture.....	12
Ecology & Control.....	13
Cultivation.....	14
<i>Silybum</i> – Historical Uses.....	17
<i>Silybum</i> - Modern Medicinal Use and Research.....	18
The Liver.....	18
Cancer.....	21
Neural Effects.....	23
Type II Diabetes.....	24
Veterinary Applications.....	25
<i>Silybum</i> – Chemistry & Biosynthesis.....	25
<i>Silybum</i> - Extraction.....	26
Current Methodologies.....	27
Supercritical Fluid Extraction.....	28
Pressurized Liquid Extraction.....	29
Microwave-assisted Extraction.....	31
<i>Silybum</i> analysis.....	32
III. Preliminary Study, Germination Tests, and Sterilization Procedure	34
Abstract.....	34
Introduction.....	35
Materials & Methods.....	36
Preliminary Study.....	36
Initial Germination Study.....	38
Surface Sterilization Technique.....	39
Results.....	40
Preliminary Study.....	40
Initial Germination Study.....	41
Discussion.....	42
Preliminary Study.....	42
Initial Germination Study.....	43

IV. Flavonolignan Content of Various Seed Sources.....	44
Abstract.....	44
Introduction.....	44
Materials & Methods	44
Results.....	45
Discussion.....	45
V. Population Density Effects on Growth, Yield, and Flavonolignan Production....	47
Abstract.....	47
Introduction.....	47
Materials & Methods	49
Results.....	50
Discussion.....	51
VI. Daily Water Rate Effects on Growth, Yield, and Flavonolignan Production.....	52
Abstract.....	52
Introduction.....	53
Materials & Methods	54
Results.....	55
Discussion.....	56
VII. Summary & Overall Conclusions.....	58
Flavonolignan Content.....	58
Other Considerations	59
UV Light.....	59
Conjugated Flavonolignans	59
Further Research.....	60
Literature Cited	62
Appendix A: Figures.....	78
Appendix B: Tables.....	103
Appendix C: Chromatographs and DAD Spectra.....	113
Appendix D: Procedures	134
Vita	142

List of Tables

Table B-1: Solvent gradient for HPLC analysis of milk thistle (<i>Silybum marianum</i>) seeds.....	104
Table B-2: Growth and yield parameters of milk thistle (<i>Silybum marianum</i>) in different single leaf removal treatments.	104
Table B-3: Concentrations of silymarin and silymarin components in milk thistle (<i>Silybum marianum</i>) seeds in different single leaf removal treatments.	105
Table B-4: Concentrations of unknown compounds in milk thistle (<i>Silybum marianum</i>) seeds in different single leaf removal treatments.....	105
Table B-5: Concentrations of silymarin components in various sources of milk thistle (<i>Silybum marianum</i>) seeds.....	106
Table B-6: Concentrations of unknown compounds in various sources of milk thistle (<i>Silybum marianum</i>) seeds.....	107
Table B-7: Growth and yield parameters of milk thistle (<i>Silybum marianum</i>) at different populations of plants per container.....	108
Table B-8: Concentration of silymarin and individual flavonolignans in milk thistle (<i>Silybum marianum</i>) seeds at different populations of plants per container.....	109
Table B-9: Concentration of unknown compounds in milk thistle (<i>Silybum marianum</i>) seeds at different populations of plants per container.....	110
Table B-10: Elemental content of fertilizer concentrate (mg/L) used to fertigate milk thistle (<i>Silybum marianum</i>) in a hydroponic experiment with different water rates.	111
Table B-11: Six yield parameters of milk thistle (<i>Silybum marianum</i>) at different daily water rates.	112
Table B-12: Growth data of milk thistle (<i>Silybum marianum</i>) at different daily water rates.....	112

List of Figures

Figure A-1: Chemical structures of silymarin components found in milk thistle seeds.	79
Figure A-2: <i>Silybum marianum</i> in flower in preliminary experiment.....	80
Figure A-3: Effect of single leaf removal treatments on plant height in milk thistle (<i>Silybum marianum</i>) seeds.....	81
Figure A-4: Effect of single leaf removal treatments on number of mature seeds in milk thistle (<i>Silybum marianum</i>).....	81
Figure A-5: Effect of single leaf removal treatments on mature and total seed weights in milk thistle (<i>Silybum marianum</i>)	82
Figure A-6: Effect of single leaf removal treatments on concentrations of silymarin components in milk thistle (<i>Silybum marianum</i>) seeds	83
Figure A-7: Effect of single leaf removal treatments on total levels of silymarin in milk thistle (<i>Silybum marianum</i>) seeds.	84
Figure A-8: Effect of single leaf removal treatments on concentrations of unknown compounds in milk thistle (<i>Silybum marianum</i>) seeds	85
Figure A-9: Concentration of silymarin components in various sources of milk thistle (<i>Silybum marianum</i>) seeds.....	86
Figure A-10: Flavonolignan profile in various sources of milk thistle (<i>Silybum marianum</i>) seeds	87
Figure A-11: Total concentrations of silymarin in various sources of milk thistle (<i>Silybum marianum</i>) seeds.....	88
Figure A-12: Experimental design for population density effects on growing plants....	89
Figure A-13: One block of all population density treatments of milk thistle (<i>Silybum marianum</i>) between true leaf stages 10-20.	89
Figure A-14: Growth data collection and seed harvest of milk thistle (<i>Silybum marianum</i>) in population density treatments in walk-in growth chamber.....	90
Figure A-15: Number of blooms per plant in milk thistle (<i>Silybum marianum</i>) grown at different numbers of plants per container ($R^2=0.59$)	91
Figure A-16: Bloom diameter in milk thistle (<i>Silybum marianum</i>) grown at different numbers of plants per container ($R^2=0.72$).....	91
Figure A-17: Number of mature seeds in milk thistle (<i>Silybum marianum</i>) grown at different numbers of plants per container ($R^2=0.54$)	92
Figure A-18: Weight of mature seeds in milk thistle (<i>Silybum marianum</i>) grown at different numbers of plants per container ($R^2=0.53$)	92
Figure A-19: Silymarin concentration in milk thistle (<i>Silybum marianum</i>) seeds from varying population densities	93
Figure A-20: Experimental design for water stress experiment	94
Figure A-21: Hydroponic apparatus in greenhouse used to determine the effects of water stress on milk thistle (<i>Silybum marianum</i>) plants.	95
Figure A-22: Average stem height per plant in milk thistle (<i>Silybum marianum</i>) grown under varying daily water rates.....	96

Figure A-23: Average bloom diameter per plant in milk thistle (<i>Silybum marianum</i>) grown under varying daily water rates.....	97
Figure A-24: Average count of immature seeds per plant in milk thistle (<i>Silybum marianum</i>) grown under varying daily water rates.....	98
Figure A-25: Taxifolin concentration in primary blooms of milk thistle (<i>Silybum marianum</i>) grown under varying daily water rates.....	99
Figure A-26: Silymarin concentration in primary blooms of milk thistle (<i>Silybum marianum</i>) grown under varying daily water rates.....	100
Figure A-27: Silymarin concentration in secondary blooms of milk thistle (<i>Silybum marianum</i>) grown under varying daily water rates.....	101
Figure A-28: Aphids and whiteflies on a milk thistle (<i>Silybum marianum</i>) leaf in hydroponic greenhouse production.....	102
Figure C-29: Chromatograph of taxifolin standard.....	114
Figure C-30: Spectra for taxifolin standard.....	114
Figure C-31: 3-D spectra of taxifolin standard.....	115
Figure C-32: Chromatograph of silybin standard (with silybin A and B).....	116
Figure C-33: Spectra for silybin A.....	116
Figure C-34: Spectra for silybin B.....	117
Figure C-35: 3-D spectra of silybin A.....	118
Figure C-36: 3-D spectra of silybin B.....	119
Figure C-37: Chromatograph of hesperetin (internal standard).....	120
Figure C-38: Spectra for hesperetin.....	120
Figure C-39: 3-D spectra of hesperetin.....	121
Figure C-40: HPLC chromatograph of silymarin profile of milk thistle (<i>Silybum marianum</i>) grown at a density of two plants per container.....	122
Figure C-41: HPLC chromatograph of unknown compounds in milk thistle (<i>Silybum marianum</i>) seeds grown at a density of two plants per container.....	123
Figure C-42: HPLC chromatograph of silymarin profile of milk thistle (<i>Silybum marianum</i>) grown at a density of four plants per container.....	124
Figure C-43: HPLC chromatograph of unknown compounds in milk thistle (<i>Silybum marianum</i>) seeds grown at a density of four plants per container.....	125
Figure C-44: HPLC chromatograph of silymarin profile of milk thistle (<i>Silybum marianum</i>) grown at a density of eight plants per container.....	126
Figure C-45: HPLC chromatograph of unknown compounds in milk thistle (<i>Silybum marianum</i>) seeds grown at a density of eight plants per container.....	127
Figure C-46: HPLC chromatograph of silymarin profile the secondary blooms of a milk thistle (<i>Silybum marianum</i>) plant grown at water rate of 2000 mL/day.....	128
Figure C-47: HPLC chromatograph of unknown compounds in seeds from secondary blooms of a milk thistle (<i>Silybum marianum</i>) plant grown at water rate of 2000 mL/day.....	129
Figure C-48: HPLC chromatograph of silymarin profile the secondary blooms of a milk thistle (<i>Silybum marianum</i>) plant grown at water rate of 650 mL/day.....	130

Figure C-49: HPLC chromatograph of unknown compounds in seeds from secondary blooms of milk thistle (<i>Silybum marianum</i>) grown at water rate of 650 mL/day.....	131
Figure C-50: HPLC chromatograph of silymarin profile of milk thistle (<i>Silybum marianum</i>) seeds from Frontier Natural Products Co-op	132
Figure C-51: HPLC chromatograph of unknown compounds in milk thistle (<i>Silybum marianum</i>) seeds from Frontier Natural Products Co-op	133

Nomenclature

C	Celsius
cm	centimeter
g	gram
kg	kilogram
m	meter
m ³	cubic meter
min	minute
μL	microliter
μm	micrometer
mg	milligram
mg/mL	milligram per milliliter
mg/g	milligram per gram
mm	millimeter
nm	nanometer
ppm	parts per million
r.l.i.	percentage of full sunlight
Tbsp	tablespoon

Abbreviations

AD	Anno Domini (current era)
BCE	before current era
CAM	complementary alternative medicine
CE	capillary electrophoresis
¹³ C-NMR	carbon nuclear magnetic resonance
CO ₂	carbon dioxide
DAD	diode array detector
DNA	deoxyribonucleic acid
IR	infrared
ISA	isosilybin A
ISB	isosilybin B
¹ H-NMR	proton nuclear magnetic resonance
HPLC	high performance liquid chromatography
MAE	microwave-assisted extraction
MIC	minimum inhibitory concentration
MS	mass spectrophotometry
NSAIDs	non-steroidal anti-inflammatory drugs
PLE	pressurized liquid extraction
RCB	randomized complete block
RCF	relative centrifugal force

RNA	ribonucleic acid
ROS	reactive oxygen species
SA	silybin A
SC	silychristin
SC	silydianin
SB	silybin B
SDS	sodium dodecyl sulfate
SFE	supercritical fluid extraction
TLC	thin layer chromatography
TTL	total
TX	taxifolin
UV	ultraviolet

I. Introduction

Plants produce a number of secondary metabolite compounds that are not involved in primary metabolic processes (such as photosynthesis, transpiration, and respiration). While first thought to be waste products, in reality these compounds serve various important roles within the plant. Some compounds provide protection for the plant against herbivory and insect or pathogen attack, while others attract pollinators or function allelopathically to decrease competition with other plants (Hadacek, 2002). Secondary metabolites are of great interest not only because of their unique functions within plants themselves, but also for their potential impact on human health. Many secondary metabolites, which function for protective purposes in plants, exhibit antimicrobial or medicinal properties (Bourgaud et al., 2001). Since recorded history, man has recognized these compounds' characteristics and has used plants for a variety of medicinal uses. The levels of secondary metabolites produced in plants can be environmentally as well as genetically controlled (Singh et al., 2003).

Silybum marianum (L.) Gaertner, also known as milk thistle, is a medicinal plant containing hepatoprotectant flavonolignans. The flavonolignans in *Silybum* that exhibit these medicinal properties are collectively known as silymarin. Originally, silymarin was thought to be one large, complex molecule. However, in 1974, it was found that silymarin is actually a mixture of several flavonolignans (Wagner, 1974). Flavonolignans are formed through the free-radical oxidative coupling of the flavonoid dihydroquercetin (also called taxifolin), and coniferyl alcohol (a component of lignan)

(Kim et al., 2003; Kurkin, 2003). This reaction forms silybin, thought to be the most bioactive component of silymarin, and a mixture of regioisomers and diastereomers (Kurkin, 2003). The three main flavonolignans in *Silybum* are silybin (also referred to as silybinin), silychristin and silydianin. Furthermore, diastereomers of silybin (silybin A and B) have been isolated, as well as the regioisomers of silybin, isosilybin A and B (Lee and Liu, 2003). Most recently, a diastereomer of silychristin (now known as silychristin A) was discovered and referred to as silychristin B (Martin et al., 2006). Structures of these compounds can be seen in *Figure A-1* (refer to Appendices for all tables and figures). Other minor compounds include dehydrosilybin, desoxysilychristin, desoxysilydianin, silybinome, isosilychristin, silymonin, silandrin, silyhermin, and neosilyhermins A and B. These compounds are found throughout the plant, but are most concentrated in the seeds. The compounds found in *Silybum* can act to prevent liver problems, as well as treat acute liver poisoning or chronic disease. Investigations have also been made into the use of milk thistle for treating various types of cancer, controlling cholesterol, promoting nerve system health, and regulating blood sugar in those with type II diabetes.

The objectives of this research were to determine the individual effects of population density and water stress on growth, yield, and the quality and quantity of flavonolignans produced in milk thistle.

II. Literature Review

Overview of secondary metabolites

Plants produce a number of secondary metabolic compounds that are not involved in primary metabolic processes (photosynthesis, transpiration, respiration). These compounds are formed via biochemical pathways that diverge from primary plant metabolism. While first thought to be waste products, in reality these compounds serve various important roles within the plant. Many times these compounds provide protection for the plant against herbivory and insect or pathogen attack. Others functions are to attract pollinators or work allelopathically to decrease competition with other plants (Hadacek, 2002). Secondary metabolites can also protect the plant against UV radiation and damage. Others function in overflow storage or disposal of waste products from primary metabolism or are recycled into primary metabolism during leaf senescence. (Wills et al., 2000) These compounds are essential for plant survival and reproductive success.

The levels of secondary metabolites produced in plants can be environmentally as well as genetically controlled (Singh et al., 2003). Secondary metabolites also indicate differentiation between plant families. For example, Lamiaceae, the mint family, contains iridoids and essential oils that are not common in other families. Solanaceous plants contain tropane and steroidal alkaloids. These biochemical variations among plant families and genera can be attributed in part to phylogenetic and ecological influences.

The development of these different combinations of secondary metabolites in plants has allowed adaptation to and in the environment. (Wink, 2003)

Secondary metabolites are of great research interest not only because of their unique functions within plants themselves, but also for their potential impact in human health. Many secondary metabolites that exhibit antimicrobial or medicinal properties function for protective purposes in plants. (Bourgaud et al., 2001) Most pharmacologically active secondary plant metabolites are generated from the shikimate, acetate-malonate, and acetate-mevalonate pathways. Classes of these compounds include terpenoids (like saponins, carotenoids, and steroids), phenolics (like flavonoids, tannins, quinines, salicylates, and lignins), alkaloids, polysaccharides, and peptides. Essential oils and resins are also important and often contain chemicals from multiple classes of secondary metabolites. (Wills et al., 2000) Man has historically recognized these compounds' characteristics and has used plants containing them for medicinal purposes. Many secondary metabolites are still under-researched as to their potential as medicines (Singh et al., 2003; Wills et al., 2000).

Medicinal Plants (general)

Written documents from early Chinese, Indian, and Near East cultures indicate the use of plants as medicine spanning back at least 5,000 years. Perhaps plants have provided medicine for humans as long as the species has existed. (Hamburger and Hostettmann, 1991) Today, many commercial drugs have their basis in compounds discovered in plants. Plants still contain vast potential for the basis of new synthetic

drugs, as well as the use of the whole plant or plant parts themselves as medicine. The past 50 years have seen a great increase in analytical scientific methods for the investigation of the constituents and biological activity that is found in medicinal plants. Ethnopharmaceutical and ethnobotanical studies have increased anthropogenic inspiration for scientific research into the efficacy of these beneficial plants. Chromatographic (TLC, GC, HPLC), spectroscopic (UV, IR, ¹H- and ¹³C-NMR, MS), and biological (various bioassays) techniques are used in the growing area of medicinal plant research. Plants that have received research attention in recent years have demonstrated anticancer, anti-inflammatory, immunostimulatory, antimicrobial, and antibiotic properties; furthermore, the potential for continued validation and discovery of herbal preparations necessitates further research (Phillipson, 2003).

In Germany, the widespread research and use of medicinal plant preparations (also termed phytopharmaceuticals or phytomedicines) have been common since the 1980's. Over 300 clinical studies used standardized phytopharmaceuticals, including *Silybum*, *Echinacea*, *Aesculus*, *Hypericum*, *Ginkgo*, *Valeriana*, *Allium sativum*, *Viscum*, *Sabal*, *Urtica*, *Crataegus*, and Kava-Kava. These studies investigated the use of these preparations for the treatment of moderate or moderately severe diseases and for the prevention of disease. Several of the clinical trials showed that the herbal preparations had full therapeutic equivalence with synthetic drugs without adverse side-effects. The action of plant extracts vary greatly from the drugs used to treat the same ailments. The

action of the herbal preparations can be characterized as polyvalent, and interpreted as additive or even potentiating. (Wagner, 1999)

Synergistic interactions that occur between compounds in herbal preparations or phytomedicines are of great importance. Synergism often explains the efficacy of a preparation, especially when needed in only small doses. The bioactivity, or efficacy, of one compound in an herbal mixture often decreases when isolated from the mixture. This is true both in single-plant preparations as well as phytomedicines containing more than one plant. The use of whole or partially purified extracts containing multiple active ingredients is essential to the philosophy of herbal medicines. (Williamson, 2001)

Modern Opinion

The medicinal use of herbs by numerous cultures can be found throughout history. On the North American continent, Native Americans used various herbs for antifungal, bactericidal, larvicidal, and molluscicidal properties. Extracts of nineteen plants with reported Native American use were screened for these various bioactivities. Plants demonstrating bioactivity included *Actaea pachypoda*, *Actaea rubra*, *Apocynum androsaemifolium*, *Aralia hispida*, *Asarum canadense*, *Caulophyllum thalictroides*, *Gaultheria procumbens*, *Geocaulon lividum*, *Ledum groenlandicum*, *Pyrola elliptica*, *Sambucus canadensis*, *Scutellaria epilobifolia*, *Scutellaria lateriflora*, *Sorbus americana* (Bergeron et al., 1996). Moreover, many of the native herbs that are commercially available today were used by Native Americans for similar purposes. Seven of the top ten most commonly sold herbal supplements in the United States were employed by Native Americans. These plants include ginseng (*Panax quinquefolius*, *P. ginseng*,

Eleutherococcus senticosus), garlic (*Allium sativum*), Echinacea (*Echinacea purpurea*, *E. angustifolia*, *E. pallida*), goldenseal (*Hydrastis canadensis*), St. John's wort (*Hypericum perforatum*), evening primrose (*Oenothera biennis*), and cranberry (*Vaccinium macrocarpon*). (Bergeron et al., 1996; Borchers et al., 2000)

Much of the world, especially developing countries, still depends on traditional medicine or a mix of traditional and Western medicine for the treatment of medical problems. However, there has been a limited amount of interaction and research performed to evaluate and compare Western and traditional medicines. The perception by Western medical practitioners that traditional or herbal medicine is not founded in science dominates. Nevertheless, interest in herbal medicine is growing along with the need for Western methodologies to discover new, effective drugs. As was done in the development of early drugs, researchers are investigating to plants as a source of medicinal secondary metabolites in an attempt to isolate novel compounds. (Taylor et al., 2001)

There are several reasons that the population at large is becoming more interested in natural remedies and herbal medicine. First, consumers are interested in a more natural way of life. As the world around us becomes more complex, more people desire to return to their proverbial roots. There has also been an increase in dissatisfaction among consumers toward modern health care because of expense, undesirable or dangerous side effects, and ineffectiveness. Finally, as Americans have more leisure time, more time is spent on one's health and fitness, especially in a society where aging

baby boomers are becoming more concerned with prolonging their health and active lifestyles. (Brevoort, 1996)

Complementary/alternative medicine (CAM) includes not only herbal medicine, but also treatments such as acupuncture, reflexology, and chiropractic care. Three surveys performed in recent years show an increase in use of CAM and an insignificant increase in healthcare professionals use and knowledge about CAM, specifically herbal and dietary supplements. In a 2003 study, Madsen et al. conducted a survey of pediatric patients (age 0-18) profiling CAM use in Denmark. Fifty-three percent of those interviewed had used CAM at least once, and 23% had tried CAM within the last month (15% of that consisting of herbal medicines). Fifty percent of patients had experienced positive effects, with 6% reporting side effects of treatment. The authors note that their results of 53% of interviewees reporting CAM use is higher than reported in previous Danish studies and studies from other countries.

Kemper et al. (2003) performed a cross-sectional survey of healthcare professionals in the Boston, MA area including physicians (MD), advanced practice nurses (RN), pharmacists (PharmD), and dietitians (RD). 66% of those interviewed reported receiving professional education about herbs and other dietary supplements (H/DS) in the past year. However, on the questionnaire about H/DS remedies, the highest scoring group (dietitians) scored an average of less than 60% of possible points. Despite the growing knowledge and interest of the consumer/patient for herbal therapies,

this study indicates that most health care professionals do not have adequate knowledge of or interest in herbs or other dietary supplements.

A 2007 survey at Georgetown University School of Medicine in Washington D.C. evaluated first- and second-year medical students' attitudes toward CAM in their medical school curriculum and in their future practice. In this study, CAM included acupuncture, herbal medicine, nutritional supplements, biofeedback, bioelectromagnetic therapies, aromatherapy, homeopathy, chiropractic, massage, hypnosis/guided imagery, music, prayer/spiritual healing, Rolfing (structural reintegration), therapeutic touch and meditation. Students indicated that in 11 these of 15 modalities the desired level of training was "sufficient to advise patients about use," (Chaterji et al., 2007). The researchers found that 91% of students agreed that Western medicine could benefit from ideas and methods included in CAM. More than 85% agreed that "knowledge about CAM is important to me as a student/future practicing health professional," and more than 75% of students thought that CAM should be included in the curriculum (Chaterji et al., 2007). The highest level of interest was in acupuncture, chiropractic, herbal medicine, and nutritional supplements. While the students showed interest and enthusiasm toward CAM, personal experience in the survey group was not highly prevalent. (Chaterji et al., 2007)

Another problem with herbal medicine currently is the lack of standardization. This is especially important when considering the increase in self-medication among individuals who choose to use alternative medicines. (Elvin-Lewis, 2001) Compounding

the lack of standardization problem is the lack of risk-benefit profiles for herbal preparations. Risk-benefit profiles can be created by systematic reviews of controlled clinical trials published using herbal medicines. These profiles include information on any adverse side-effects of herbs as well as any known contraindications with prescription drugs. (Ernst, 2002)

Pharmacovigilance is defined as, 'the study of the safety of marketed drugs under the practical conditions of clinical usage in large communities,' (Mann and Andrews, 2002). Pharmacovigilance practices are developed to control the safety and good manufacturing practices for pharmaceutical drugs. Such standards also need to be established for herbal preparations. In addition to risk-benefit profiles, pharmacovigilance monitors adverse drug reactions and responds to and communicates drug safety concerns. These practices can assist in developing standard methods of handling plant material for medicine. This is extremely important because the quality and quantity of medicinal components in plants can be affected by factors including inter- or intraspecies variation, environmental factors (climate, growing conditions), time of harvest (can even vary depending on the time of day), and post-harvest factors (storage, drying, etc.). (Barnes, 2003)

Another important consideration in the use of herbal medicine is potential adverse interactions with prescription and over-the-counter drugs. For example non-steroidal anti-inflammatory drugs (NSAIDs), like aspirin, have the potential to increase the risk of bleeding when taken with herbs that possess antiplatelet activity (such as ginkgo, willow,

ginger, and garlic) or that contain coumarin (like chamomile and horse chestnut).

Further, acetaminophen when taken with ginkgo can also increase the risk of bleeding because of decreased platelet aggregation. On its own, acetaminophen has hepatotoxic properties, and can cause severe liver damage when taken with herbs, like kava-kava and *Echinacea*, that can cause stress to the liver. Nephrotoxicity is also possible when acetaminophen is taken concomitantly with herbs containing salicylate, like willow and meadowsweet. (Abebe, 2002)

Certain herbs can also decrease the effectiveness of prescription drugs. For example, St. John's Wort (*Hypericum perforatum*) lowers blood concentration of amitriptyline, cyclosporine, digoxin, indinavir, phenprocoumon, theophylline, and warfarin. When St. John's Wort is taken concomitantly with oral contraceptives (ethinylestradiol/desogestrel), loperamide, or selective serotonin-reuptake inhibitors (SSRIs), intermenstrual bleeding, delirium, or mild serotonin syndrome can occur. (Izzo and Ernst, 2001) These sorts of interactions and contraindications are critical to consider when one chooses to pursue herbal medicine for treatment.

Many medicinal herbs contain antimicrobial properties. One consideration in using these products is the possibility of increased antibiotic resistance. Ward et al. (2002) studied the effects of different herbal and nutraceutical products on antibiotic resistance in gram positive and gram negative bacteria. The minimum inhibitory concentration (MIC) of antibiotics (ampicillin) applied to the bacteria were recorded in the presence of the various nutraceuticals preparations. Thirteen of the preparations

resulted in an increase in MIC, two preparations showed decreases, and seven had no changes. Garlic, *Echinacea*, and zinc products all caused large increases in MIC.

Despite the possible negative or tedious aspects of taking and/or working with herbal preparations, medicinal phytochemicals can demonstrate several different modes of health benefits including the following: substrates for biochemical reactions; cofactors of enzymatic reactions; inhibitors of enzymatic reactions; absorbents or sequestrants that bind to and eliminate undesirable constituents in the intestine; ligands that agonize or antagonize cell surface or intracellular receptors; scavengers of reactive or toxic chemicals; compounds that enhance the absorption and or stability of essential nutrients; selective growth factors for beneficial gastrointestinal bacteria; and selective inhibitors of deleterious intestinal bacteria (Dillard and German, 2000).

***Silybum* – Taxonomy & Culture**

Silybum marianum (L.) Gaertner (formally known as *Carduus marianus* L.) is classified as follows: Kingdom Plantae, Division Magnoliophyta, Class Magnoliopsida, Order Asterales, Family Asteraceae, Tribe Cardueae. *Silybum* can be referred to by the common names milk thistle, variegated thistle, wild artichoke, lady's thistle, holy thistle, Mary thistle, Marian thistle, and St. Mary's thistle. Several of these common names arise from the morphology and legend of the plant. Marbled white venation occurs on the leaves. According to ancient legend, the white venation arose after being touched by the Virgin Mary's milk, which also corresponds with the plant's historical use as a galactagogue. There are two species in the genus *Silybum*, the purple flowered *S.*

marianum and the white flowered *S. eburneum* Coss. et Durieux. Both species produce hepatoprotectant flavonolignans (McKenna et al., 2002). In a genetic study, German researchers concluded that *S. eburneum* is really a variation of *S. marianum*, as opposed to being a distinct species (Hetz et al., 1995).

Milk thistle grows as an annual or biennial, depending on climate. Leaves are large, typically growing 10 cm in width and 30 to 40 cm in length. They are obovate with a cuneate base and undulate, spinose-dentate margins. The leaves are typically a dark, glossy green with white marbling on the veins. Spines, whose size ranges from 1 to 3 cm, are found both on the leaves and on the seed heads. In the vegetative stage, *Silybum* grows in a basal rosette 0.75 to 2 m in diameter. Flowers arise on stems which can reach 1 m in height in pot production; however, in natural settings milk thistle can grow taller. The flowers of *Silybum* are light purple to reddish-purple and range from 2.5 to 6 cm in diameter. The number of flower heads per plant varies greatly, with 9 to 50 flowers being produced on average. Milk thistle seeds grow between 0.5 and 0.8 mm long, and are wind-dispersed over short distances via 1 to 2 cm pappus crowns. A single seed head can produce around 100 seeds (Bean, 1985; Morazzoni and Bombardelli, 1995). Milk thistle in the wild has the potential to give rise to an average of 55 seed heads that can produce some 6,350 seeds per plant (Dodd, 1989).

Ecology & Control

Milk thistle is native to the Mediterranean, and is widespread throughout Europe. The literature describes milk thistle as synanthropic, or growing in human habitats (Danin and Yom-Tov, 1990). Wastelands, roadsides, and cultivated ground are all likely places

to find milk thistle. Areas ranging from the coast to sub-mountainous areas can be populated by *Silybum*, with it growing in altitudes of 700 to 1,100 m (McKenna et al., 2002; Morazzoni and Bombardelli, 1995).

Scientists in Israel have documented seed dispersal by ants and dense plant occurrence by ant nests. Harvester-ants move the seeds to their nests, remove the elaiosome (oily body) to feed to their larvae, and deposit the achene in the nutrient-rich waste area around the ant nest. This nutrient-rich environment promotes germination and subsequent vigor of the milk thistle plants (Danin and Yom-Tov, 1990; Gabay et al., 1994).

Due to ease of seed germination and wind-spread seed dispersal, milk thistle is somewhat invasive in some parts of Europe, Australia, and the United States (Austin et al., 1988). Invasiveness has been a problem in livestock production, as thick stands of thistle has the ability to exclude the animals from grazing and cutting off water access (Auld and Medd, 1987; Dingwall, 1950). Control methods became necessary in these areas. Control methods including pasture competition, grazing management, slashing, soil fertility management, chemical controls, and biological controls have been studied (Dodd, 1989; Sindel, 1991; Souissi et al., 2005; Zheljzkov et al., 2006)

Cultivation

Silybum is most commonly propagated through seed. Milk thistle seeds require light to germinate, and germinate easily, although sporadically, with moisture.

Germination studies have shown that seeds typically have a dormancy period after maturation lasting three to six months. (Singh et al., 1982) The normal growing season is

from early spring to summer, with flower maturation occurring from June to July.

There is nothing in the literature to indicate that *S. marianum* is photoperiodic. *Silybum* can also behave as a biennial (Carrier et al., 2002). Milk thistle is primarily produced in field cultivation and is generally regarded as having no major insect or disease problems (Andrzejewska et al., 2006).

In cultivation for medicinal use, seed production and flavonolignan content is of great importance, as the seeds are commercially used for medicinal preparations. As previously mentioned, a single milk thistle plant gives rise to numerous seed heads. Research performed in Argentina in 2002 described some of the trends governing seed production in milk thistle crops. The number of seeds per plant is affected by the number of heads per plant. The weight of the seeds per plant is the result of the number of heads per plant, the number of seeds per head, and the individual seed weight. The number of seeds per head increases with bloom diameter and decreases with the number of heads per plant. (Gabucci et al., 2002)

Pook (1983) examined the effect of shade on the growth of milk thistle in a greenhouse environment during winter. Seedling growth and rate of growth are both negatively affected by increasing shade. However, increasing shade had minor effects on seedling morphology until irradiance was reduced to less than 0.20 r.l.i. (relative light intensity; 20% of full sunlight) at what point leaf expansion and relative growth rates declined rapidly. Otherwise, seedlings demonstrated high tolerance to shading.

Other studies have shown that various agricultural conditions can affect the levels of bioactive compounds (silymarin) in milk thistle. Hammouda et al. (1993) showed that silymarin levels and individual silymarin components were affected by water availability and nitrogen levels. The highest silymarin level (63.1% silymarin in an ethyl acetate extract) was recorded in plants grown at 60% field capacity. Levels of silychristin, silybin, and isosilybin were also highest at this water level. Silydianin levels decreased with decreasing water availability. Levels of silymarin in treatments of 75% and 40% field capacity were similar to levels found in wild plants (45.7%, 45.7%, and 45.6% silymarin in an ethyl acetate extract, respectively). Higher silymarin levels were observed in nitrogen levels of 100 and 150 kg/feddan (52.2% and 52.8% silymarin in an ethyl acetate extract; feddan = 1.038 acres).

Warren (2003) also studied *Silybum* in a greenhouse environment under different nitrogen concentration. Vegetative yields were affected under different nitrogen treatments of 47.1 mg/L, 100.6 mg/L, and 151.8 mg/L. The lowest nitrogen treatment had significantly lower vegetative growth than the other two treatments. Seed yield was also affected by nitrogen availability. The highest nitrogen concentration yielded 104.7 g/plant, while the lower two concentrations were not significantly different and had an average yield of 42.1 g/plant. None of the nitrogen treatments significantly affected silymarin levels in the plants. However, all compounds appeared to increase slightly with decreasing nitrogen concentrations.

Silymarin content can also be affected by row spacing. Seeds were sown in rows of two varying widths (25 and 50 cm between rows), and seedlings were thinned to two plants per hill 30 days after seeding. Narrow row spacing of 25 cm increased the seed yield, but reduced oil and silymarin content compared to plants grown in rows 50 cm apart. (Omer et al., 1993)

***Silybum* – Historical Uses**

While initially intimidating due to its spiny nature, *Silybum* has been historically used as a food crop. Both the leaves and fruit are edible. The leaves are particularly high in iron and, when despined, can be eaten in salads or steamed as greens. Fruit can be toasted and served as a garnish for salad, rice, etc. They can also be roasted and brewed as a coffee substitute (McKenna et al., 2002).

The use of milk thistle has been documented since the time of Greek philosopher, Theophrastus, (c.371-287 BCE) who referred to the plant by the name *Pternix* (Ball and Kowdley, 2005). Pliny the Elder (23-79 AD) wrote that milk thistle was good for “carrying off bile,”(quoted in Flora et al., 1998). Dioscorides (40-90 AD), author of *de Materia Medica*, described and wrote about milk thistle’s uses, saying a tea of the seeds could cure poisonous snake bites (Ball and Kowdley, 2005; Flora et al., 1998). By the 16th century, milk thistle was popularly used for hepatobiliary diseases (Ball and Kowdley, 2005). In 1652, prominent English herbalist, Nicholas Culpeper described milk thistle as an excellent aid “to open the obstructions of the liver and spleen, and thereby is good against the jaundice,” in his work “The English Physitian” (quoted in

Ball and Kowdley, 2005). Milk thistle found its way to the Americas with early European colonists, and in the late 1800's to early 1900's the Eclectics, an American group of herbalist physicians, were using milk thistle for liver, spleen, kidney, and menstrual problems. In the 1960's milk thistle research gained new interest in Germany for the treatment for acute and chronic liver disease, as well as a hepatoprotective agent to protect against toxic liver injury. (Ball and Kowdley, 2005)

***Silybum* - Modern Medicinal Use and Research**

The compounds found in *Silybum* can act to prevent liver problems, as well as treat acute liver poisoning or disease. Investigations have also been made into the use of milk thistle for treating cancer, controlling cholesterol, promoting nerve system health, and regulating blood sugar in those with type II diabetes. Some of these studies use the complex, silymarin, while others use only silybin.

The Liver

The main functions of the liver can be broken down into three categories, regulation, synthesis, and secretion of substances important to bodily homeostasis. Nutrients, such as glycogen, and vitamins and minerals are stored by the liver; furthermore, the liver purifies, transforms, and clears waste products, drugs, and toxins from the body. The liver also possesses the capability to regenerate lost tissue, and can maintain its functions, despite moderate damage. However, injury, disease, and ingestion of toxins can greatly reduce the liver's ability to carry out its normal activities. Chronic problems can occur from regular use of common substances like alcohol and

acetaminophen, and acute distress can occur from ingesting poisonous mushrooms. Cell damage and impairment of the liver's capacity are the source of most cases of liver dysfunction. (Earnest, 2005)

The literature suggests that the medicinal flavonolignans in *Silybum* work in four different ways to achieve beneficial effects in the liver. First, they are antioxidants, anti-inflammatory, and scavengers and regulators of intracellular glutathione content. This quality helps explain other benefits outside of the liver. Secondly, the flavonolignans can behave as cell membrane stabilizers and permeability regulators to prevent hepatotoxic chemicals from entering liver cells. Thirdly, the compounds have the ability to promote RNA synthesis, helping to regenerate the liver. Finally, these compounds can inhibit the transformation of stellate hepatocytes into myofibroblasts, which is the process that leads to cirrhosis. (Fraschini et al., 2002)

Several reviews have been written in recent years summarizing milk thistle's use in the treatment of liver disease. In 2002, Jacobs et al. wrote a systematic review and meta-analysis on milk thistle for the treatment of liver disease. The group searched for and compared clinical studies done with milk thistle up until July 1999. (Jacobs et al., 2002) Two reviews were published in 2005 comparing clinical studies for milk thistle/silymarin for viral hepatitis and alcoholic liver disease (Ball and Kowdley, 2005). All of these reviews conclude that due to inconsistencies in dosages of milk thistle, source of the plant, and other experimental design flaws, no definitive statements can be made about the use or harm in using milk thistle for liver disease.

In another review, Rainone (2005) outlines some early studies conducted with milk thistle for liver disease that had positive, significant effects. In a randomized, placebo-controlled study, researchers examined 106 patients with mild acute and subacute liver disease characterized by elevated serum transaminase levels. At the end of the four week study, of the 97 patients who completed the study, there was a significant decrease in transaminase levels in the silymarin group. (Salmi and Sarna, 1982)

Ferenci et al. (1989) performed a clinical trial examining the effects of a standardized milk thistle product (standardized to contain 70 to 80% silymarin) called Legalon, which is available in Germany and elsewhere in Europe, on cirrhosis. In this study, 170 patients (46 with alcoholism) were randomized to receive Legalon or placebo for 24 to 41 months. In the 146 patients who completed the study, a lower mortality rate was reported in the group who took Legalon. The greatest benefit was found in those individuals whose cirrhosis was caused by alcoholism and in those whose cirrhosis was less severe on entry to the study.

In a 1989 double-blind study of 36 patients with chronic alcoholic liver disease, the patients who were given Legalon for six months showed normalization of bilirubin, aspartate transaminase and alanine transaminase serum levels. The levels of these liver enzymes can be used as an indicator of liver health. Patients receiving Legalon also showed an improvement in histology. These effects were not observed in the placebo group. (Feher et al., 1989)

In a 1998 study, 20 patients with chronic active hepatitis were randomized to receive silybin or placebo. The milk thistle (silybin) group had significantly lower transaminase, bilirubin, and γ -glutamyltranspeptidase levels than the placebo group. This study used silybin coupled with phosphatidylcholine, which appears to increase bioavailability. (Pares et al., 1998) This coupling creates a “phytosome” form known as silipide or Siliphos[®] (Hoh et al., 2006; Kidd and Head, 2005). The phosphatidylcholine is miscible in water and oil/lipid environments, increasing bioavailability. (Kidd and Head, 2005) This is synthesized by treating an acetone solution of silybin and phosphatidylcholine with n-hexane in a 1:1 molar ratio. The precipitate is collected and dried under vacuum. (Ball and Kowdley, 2005)

Cancer

The number of studies using silymarin, silybin, and other milk thistle preparations for various types of cancer has increased in recent years. Prostate, colorectal, skin, and mammary cancers have been studied. Effects of silymarin compounds on cancer-causing factors, like angiogenesis and reactive oxygen species (ROS), have also been studied. These effects have been studied in cell lines, animal, and human models.

Silymarin and silybin were studied to determine their antiproliferative and apoptotic effects on rat prostate cancer cells. Both compounds displayed antiproliferative and apoptotic effects, as well as a strong inhibition of DNA synthesis. Both compounds worked in a time- and dosage-dependent manner with low toxicity. The authors suggest that these compounds have the potential to be preventative and therapeutic against prostate cancer (Tyagi et al., 2002) Silymarin and silybin had cell cycle-inhibitory

effects in human prostate carcinoma PC3 cells. In this study, silybin and silymarin (50-100 µg/mL) inhibited cell proliferation, induced cell death, and cause G1 and G2-M cell cycle arrest in a time- and dosage-dependent manner. The authors suggested that silybin was the major active compound, but other stereoisomers (isosilybin A & B, silydianin, silychristin, and isosilychristin) in the silymarin mixture contribute to its efficacy. (Deep et al., 2006)

Angiogenesis is known to be associated with tumor growth in the body. Yang et al. (2003) studied the anti-angiogenic effect of silymarin and silybin compared to the drug thalidomide in LoVo colon cancer cells. They found that silymarin and silybin exhibited a comparable, if not better, effect on anti-angiogenesis in the colon cancer cells. The authors go so far as to suggest silymarin/silybin as an anti-cancer treatment, especially when considering the extremely low toxicity of silymarin and silybin. In a 2006 pilot study, oral silybin (in the form of silipide) was given to patients with confirmed colorectal adenocarcinoma at rates of 360, 720, or 1,440 mg silybin daily for 7 days. The authors identified several silybin metabolites and conjugates in plasma and tissue of the patients at levels similar to known pharmacologic activity levels. While the levels used in this study did not affect apoptosis and antioxidant markers in the blood, the treatments were determined as safe and deserving of further study as a human colorectal cancer chemopreventative agent. (Hoh et al., 2006)

Silymarin and its components have been shown effective against UV damage and skin cancer. Silybin was evaluated for effect on UV irradiation-induced apoptosis in

human malignant melanoma cells (A375-S2 cells) by Li et al. Cells were treated with 500 μ M silybin for 12 hours. This significantly inhibited UV irradiation-induced apoptosis in the cells. (Li et al., 2004) In a 2007 study, skin epidermal cell line HaCaT was used to study UVA-induced damage. UVA-induced oxidative stress was reduced in a concentration-dependent manner with silymarin concentrations ranging from (0.7-34 mg/L). Silymarin reduced the generation of reactive oxygen species with lead to inflammation, immunosuppression, photoaging, and photocarcinogenesis. UVA-induced DNA single strand breaks and caspase-3 activity were also significantly decreased by silymarin. (Svobodova et al., 2007)

Silymarin has also shown significant anti-inflammatory effects in liver tissue, exhibiting a number of effects. These include inhibition of neutrophil migration and Kupffer cells, as well as marked inhibition of leukotriene synthesis and formation of prostaglandins. While no molecular basis for silymarin's activity has been established, it is hypothesized that it might be related to the inhibition of transcription factor NF- κ B. This transcription factor regulates the expression of genes involved in the inflammatory process, cytoprotection, and carcinogenesis. (Fraschini et al., 2002; Polyak et al., 2007)

Neural Effects

The efficacy of flavonolignans from milk thistle on neurons in culture has also been studied, suggesting potential benefits these compounds have on the nervous system. Kittur et al. found that milk thistle seed extract promoted neuronal differentiation, enhanced nerve growth factor-induced neurite outgrowth and promoted neuron survival in

PC-12 (pheochromocytoma) cells. Milk thistle extract also prevented oxidative stress-induced cell death in cultured rat primary hippocampal neurons. (Kittur et al., 2002)

The effects of silymarin on brain amines and metabolites were studied using BALB/c mice. Mice were treated intraperitoneally (into the abdominal cavity lining) with 0, 10, 50, or 250 mg/kg of silymarin for 5 days. Serotonin levels in the cortex and dopamine and norepinephrine levels in the cortex were increased in the highest treatment group. This indicates that silymarin may have slight serotonergic, dopaminergic, and noradrenergic effects. (Osuchowski et al., 2004)

Type II Diabetes

Silymarin is effective in the treatment of type II diabetes. Oxidative stress can either cause pancreatic β -cell damage and metabolic abnormalities that can cause or aggravate diabetes. A 4-month randomized, double-blind clinical trial was performed in 51 patients with type II diabetes. One group received a 200 mg silymarin tablet 3 times a day plus conventional therapy. The other group received a placebo tablet and the same conventional therapy. After 4 months, levels of glycosylated hemoglobin, fasting blood glucose, total cholesterol, low density lipoprotein, triglyceride, SGOT, and SGPT were significantly lowered in the silymarin group. A slight, but not significant, decrease in weight, systolic and diastolic blood pressure was found in the silymarin group. The authors concluded that silymarin does have beneficial effects on the glycemic profile in individuals with type II diabetes. (Huseini et al., 2006) These results correlate with earlier studies performed on silymarin as a hypocholesterolaemic drug, its effect on

cholesterol absorption in rats, and effect on oxidative stress in hypertriglyceridemic rats (Skottova et al., 2004; Skottova and Krecman, 1998; Sobolova et al., 2006)

Veterinary Applications

Some research has been done using milk thistle in veterinary applications. In a review of pharmacologic therapies for hepatobiliary diseases in dogs and cats, the author mentions milk thistle as a hepatoprotector with little to no side effects or contraindications (Sartor and Trepanier, 2003). In a 2004 study, a silymarin-phospholipid complex was shown effective in reducing toxicity of aflatoxin B₁ in broiler chickens. Aflatoxin B₁ is a mycotoxin commonly associated with animal feed, especially feeds made with peanuts and cereals. (Tedesco et al., 2004a) Silymarin has also been beneficial in dairy cows during peripartum, a time where the cows are subject to fatty liver (Tedesco et al., 2004b). Furthermore, milk thistle silage lowered triglycerides and liver enzymes in cows, and the silage positively influenced the enzymatic activity of blood serum in the transition period after calving (Grabowicz et al., 2004).

Silybum – Chemistry & Biosynthesis

The major class of biologically active compounds found in *Silybum* is known as flavonolignans. The group of flavonolignans in *Silybum* that exhibit hepatoprotective properties is known as silymarin. Silymarin was originally thought to be one large, complex molecule. However, in 1974, it was found that silymarin is actually a mixture of several flavonolignans. (Wagner, 1974) Flavonolignans are formed through the free-radical oxidative coupling of the flavonoid dihydroquercetin (also called taxifolin) and

coniferyl alcohol (a component of lignan) (Kim et al., 2003; Kurkin, 2003) This reaction forms silybin, thought to be the most bioactive component of silymarin, and a mixture of regioisomers and diastereomers (stereoisomers that are not mirror images of one another) (Kurkin, 2003). The three main flavonolignans in *Silybum* are silybin (also referred to as silybinin), silychristin and silydianin. Diastereomers of silybin (silybin A and B) have been isolated, as well as the regioisomer of silybin, isosilybin A and B via X-ray crystallographic analysis and optical rotation data coupled with ^{13}C and ^1H NMR spectral data (Lee and Liu, 2003). (Figure A-1) Kurkin et al. (2001) achieved the identification of 2,3-dehydrosilybin with the use of UV and ^1H -NMR spectroscopies (Kurkin et al., 2001). Most recently, a diastereomer of silychristin (now known as silychristin A) was discovered and referred to as silychristin B (Martin et al., 2006). Other minor compounds include dehydrosilybin, desoxysilychristin, desoxysilydianin, silybinome, isosilychristin, silymonin, silandrin, silyhermin, and neosilyhermins A and B.

In addition to the flavonolignans, there are many other compounds of interest in *Silybum*. Most recently, two pentacyclic triterpenes were elucidated named silymin A and B (Ahmed et al., 2007).

***Silybum* - Extraction**

In order to obtain silymarin from milk thistle, the desired compounds must be extracted from the seeds. The extraction of desired compounds from a solid matrix, such as plant material, can be thought of as a five step process, and each step of the process requires careful control for optimization of the overall extraction. These steps include the

desorption of the compound(s) from the active sites of the matrix, diffusion of the compound(s) into the matrix itself, solubilization of the analyte in the extractant, diffusion of the compound in the extractant, and collection of the extracted solutes. (Camel, 2001; Pawliszyn, 1993) Traditionally, compounds have been extracted using Soxhlet extraction, sonication, and blending; however, these methods normally require long extraction times, high solvent use, and low temperatures. Furthermore, these methods often require subsequent clean-up, concentration, and perhaps filtration of the desired compounds before analysis. These steps introduce a high probability of loss and/or contamination of the sample. There are several technologies that have emerged in the past decade that reduce these problems and ease the optimization of the extraction process. These technologies include supercritical fluid extraction, pressurized liquid extraction, and microwave-assisted extraction. (Camel, 2001) All of these methods have potential for use in milk thistle extraction for analysis.

Current Methodologies

There are many studies that explore the possible methods for silymarin extraction, and there are several considerations when preparing these extractions. Silymarin compounds are most highly concentrated in the seeds of milk thistle, and are hydrophobic. For the most effective silymarin recovery, the seeds should be defatted prior to extraction. Furthermore, the polarities of the silymarin compounds have a wide range, with taxifolin being highly polar, to silybin A & B which are only slightly polar. (Barreto et al., 2003) The solvents, temperatures, and time durations of the extractions all have to be adjusted accordingly to achieve the most efficient and complete extract.

Pharmacopoeias call for long extractions using a Soxhlet apparatus. This can be adapted using series of sonication, vortexing, and centrifugation to achieve complete extracts. Still, other new technologies have been developed that can maximize the extraction process.

Supercritical Fluid Extraction

In supercritical fluid extraction (SFE) the extractant (or solvent) is in its supercritical state, where both temperature and pressure are beyond the critical state of the solvent. This gives the solvent unique properties of both liquid and gas in that the viscosity is lower than that of liquid and the diffusion coefficients are higher. This allows for more efficient extractions. Polarity of the compounds to be extracted is of primary consideration. (Camel 2001) Pure carbon dioxide (CO₂) is the most commonly used solvent in SFE because of its low critical constants, it is non-toxic, non-flammable, and is available in high purity at low cost. (Feher et al., 1989) CO₂ efficiently extracts non-polar to low polarity compounds; however, the addition of a modifier solvent to the CO₂ is required for effective extraction of mid to highly polar and ionic compounds. (Camel, 2001)

Methanol is commonly used as a modifier in supercritical extraction because of its miscibility with CO₂, and methanol is thought to have the ability to disrupt the bonding between solutes and plant matrices at high percentages; however, ethanol is also an attractive modifier as it is less toxic than methanol (Lang and Wai, 2001). Several studies have been done with the use of ethanol as a modifier. Catchpole et al. (2002) studied different solvent mixtures for supercritical extractions for four popular herbs, saw

palmetto, St. John's wort, kava root, and *Echinacea purpurea*. While adding ethanol to the CO₂ did increase the yield of compounds from some plants, it also increased undesirable compounds into the extract, like some color components and high molecular weight waxes. The supercritical extraction also did not retrieve all the desired chemicals out of the plant matrices, even with the addition of ethanol to the solvent. For example, when *Echinacea* was extracted using both CO₂ only and CO₂ + ethanol, high levels of alkaloids were extracted, but no chicoric acid or polyphenolics were obtained in the extract.

Pressurized Liquid Extraction

Pressurized liquid extraction (PLE) is a new technique that has been developed over the past 10 years. This form of extraction appears under several different names including accelerated solvent extraction (ASE™, a Dionex trade mark), pressurized fluid extraction (PFE), pressurized solvent extraction (PSE), or enhanced solvent extraction (ESE). In this form of extraction, temperature and pressure are elevated, placing the solvent in a subcritical state, which provides greater mass transfer properties. Elevated temperature (usually between 100-200 C) allows for a decrease in solvent viscosity, thus disrupting the solute-matrix interactions and increasing diffusion coefficients more efficiently. Furthermore, elevated temperatures cause a change in the distribution coefficients of the desired compounds which allows for greater solubilization into the solvent. Under these conditions, a complete extract from a sample can typically be obtained in 5-10 minutes. (Camel, 2001)

Benthin et al. (1999) investigated the extraction efficiency of pressurized liquid extraction (PLE) of five various medicinal plant species compared to Pharmacopoeia monographs (which serve as official standards for the quality control of many medicinal plants). PLE works on the principle of static extraction with superheated liquids. The Pharmacopoeia guidelines for milk thistle analysis include a 4 hour Soxhlet extraction in petrol for defatting, with a subsequent 5 hour Soxhlet extraction with methanol to extract the flavonolignans. These extracts were compared to PLE extracts which were obtained in a single extraction cycle using a 5 minute extraction in hexane at 100 C for seed defatting, followed by a 5 minute extraction in methanol at 100 C. For the extraction of milk thistle, the group found that the PLE extract yielded slightly higher amount of flavonolignans in far less time and with five times less solvent consumption than the Pharmacopoeia guidelines. Overall, the group found that PLE extractions saved a significant amount of time and solvents for extractions and extracted equal or greater amounts of the medicinal compounds.

Another exciting possibility for PLE extraction is the option to use hot water as a solvent. Water is useful in extracting polar compounds, but has the unique capability of extracting plant material without the necessity of prior defatting. When water is heated up to its subcritical temperature, there is a decrease in the dielectric constant, or permittivity. Therefore, water at 250 C has a dielectric constant of 27, which is similar to that of methanol (33) and ethanol (24), which gives water, at this temperature, solubility characteristics of these two organic solvents. (Barreto et al., 2003) The temperature of

water in a PLE cell can be increased over a period of time, and based on the polarities of the desired compounds in a sample, various compounds will be pulled out of the plant matrix as the temperature increases. For example, Barreto et al. (2003) demonstrated that the more polar compounds in a milk thistle seed sample (taxifolin and silychristin) could be pulled out in a hot water extraction at 85 C and the less polar compounds (silybin A and B) were extracted at 100 C. Furthermore, they saw an increase in the yield of more polar compounds in the hot water extraction over the traditional Soxhlet extraction in ethanol. Finally, the hot water method is also advantageous in that since the solvent used is water, there is no required, further clean-up of the extract.

Microwave-assisted Extraction

Microwave-assisted extraction (MAE) is another fairly new, effective extraction method. Microwave radiation is used to heat a solvent-sample mixture. Microwave energy is non-ionizing and causes molecular motion by migration of ions and rotation of dipoles. Dipole rotation refers to the alignment of molecules that have dipole moments (either permanent or induced) in both the solvent and the sample, due to the electric field. As microwaves are applied to an extraction cell, the molecules go through a cycle of thermal disorder followed by a re-alignment. This results in rapid heating. This heating is instantaneous and occurs in the heart of the sample which results in rapid extraction times. Typically, a solvent is chosen that absorbs microwaves, which allows for heating of both the sample and solvent; however, for thermolabile compounds, a non-absorbing solvent can be used which allows the release of compounds into a cold solvent. Microwave radiation has shown so far to have no degrading effects on extracted

compounds, unless the temperature in the extraction cell exceeds the temperature ranges for the compounds. (Camel 2001) Several studies have been done to determine the effectiveness of MAE on material from various plants, and they have proven that extracts can be generated in as little as one minute, depending on the plant and solvent used (Huie, 2002).

Silybum analysis

Many advances have been made in screening techniques for medicinal plant extracts in the past twenty years. Many of the most effective techniques include the use of high performance liquid chromatography (HPLC) coupled with a detector that has some capacity for the determination of chemical structure of the components separated by LC. The benefits arising from the use of LC in these applications is that LC is generally rapid and does not lead to decomposition, material loss, or artifact formation. Some of the most recent advances in this area are the coupling of HPLC with UV diode array detection (LC/UV), mass spectrophotometry (LC/MS), or nuclear magnetic resonance (LC/NMR). Each of these methods has benefits from the perspective of structure elucidation and/or identification. (Hostettmann and Marston, 2002)

Minakhmetov et al. (2001) achieved the complete separation, identification, and quantification of the main flavonolignan constituents from milk thistle seeds. They discovered the optimum parameters for milk thistle analysis via HPLC. Their mobile phase was a mixture of acetonitrile and water (27:73 volume %, pH 3.0). Ethanoic acid was added to the water to reach the desired pH. Through this analysis they were able to

resolve and identify silybin, silydianin, silychristin, and taxifolin. While a standard of 2,3-dehydrosilybin was used in this study, it was not found as an eluent.

Further studies have employed LC coupled with mass spectrophotometry to analyze milk thistle samples. Bilia et al. (2001 and 2002) published studies using LC/MS for the analysis of calendula, milk thistle, and passion flower. The HPLC method used was very similar to the parameters found by Minakhmetov et al. (2001). Since MS was used as a detector, the water in the mobile phase was adjusted to a pH of 3.0 using formic acid. (Bilia et al., 2002; Bilia et al., 2001)

Capillary electrophoresis (CE) is another analytical method that can be utilized for silymarin analysis. Kvasnicka et al. (2003) compared the analysis of milk thistle via HPLC to that of CE. They concluded that each method gave comparable results; however CE did provide for shorter analysis and better resolution of silydianin and silychristin over the HPLC, which HPLC allowed for the separation of the diastereomers, isosilybin A and B. Warren (2003) used CE to analyze milk thistle from hydroponic experiments to determine the effect of nitrogen levels on flavonolignans. Taxifolin, silybin, and silydianin were identified in these experiments.

III. Preliminary Study, Germination Tests, and Sterilization Procedure

Abstract

A preliminary experiment was conducted to look at the effect of leaf harvests on growth, development, and flavonolignan content in milk thistle seeds. Plants grew from seedling to maturity in approximately four months in a greenhouse environment. The flavonoid taxifolin, which is a component of silymarin and a precursor to flavonolignans, was significantly decreased by the harvesting treatments.

Due to the weedy nature of *Silybum marianum*, there were some unforeseen obstacles in germinating enough plants to conduct the proposed experiments. Germination was sporadic, and fungal seed contamination decreased seedling viability. Germination and sterilization trials were then pursued to determine the most efficient way to produce viable seedlings for experimentation. Seed germination trials were done in a growth chamber using Petri dishes with germination paper. Organically grown seeds from Johnny's Select Seeds were imbibed overnight and either placed in the chamber or pre-chilled for one week. Both groups succumbed to fungal infections before germination data could be collected. Germination trials were also performed with seven other seed sources including seeds from Frontier Natural Products Co-op (organic and non-organic seeds), Wild Weeds (two seed lots, one from Oregon and one from Croatia), Stony Mountain Botanicals, Ltd., and Richters Herbs. The seeds harvested from Croatia showed the best germination and were used for all subsequent experiments. Also, a

sterilization procedure using 70% ethanol and a 5% bleach/ 1% SDS solution was chosen to sterilize seeds before *Silybum* seeds were sown for experimental use.

Introduction

Preliminary work included growing and harvesting plants in small containers, performing germination tests on various seed sources, and determining a seed sterilization technique. The experiment growing plants in small containers occurred first with seeds from Johnny's Select Seeds. These germinated rapidly, and a small preliminary study was done by growing these seedlings in four inch trays. Ten plants were chosen to have a basal leaf between leaf stages 3-5 removed. Twenty plants were chosen to have a cauline leaf removed once the flower stem had elongated. Seed was harvested off of these plants. Seed was also harvested from twenty-four additional plants that had not had any leaves removed. Growth parameters of stem height and days to maturity were observed. The harvested seed from all the plants was analyzed for flavonolignan content.

When subsequent germination attempts were unsuccessful, germination trials were started. Organically grown seeds from Johnny's Select Seeds were used in germination trials in a small growth chamber. Seeds were germinated in Petri dishes with germination paper. Seeds were imbibed overnight and either put straight into the growth chamber or pre-chilled at 4 C for one week. These seeds were heavily contaminated with fungi, affecting germination and seedling viability. With this discovery, a reliable sterilization technique was sought out. The sterilization procedure used for all

subsequent experiments consisted of an ethanol wash followed by a bleach/SDS solution. Further germination trials were performed using seven other seed sources including seeds from Frontier Natural Products Co-op (organic and non-organic seeds), Wild Weeds (two seed lots, one from Oregon and one from Croatia), Stony Mountain Botanicals, Ltd., and Richters Herbs. After all of these initial questions were addressed and answered, further progress could be made on experiments addressing environmental stress.

Materials & Methods

Preliminary Study

Seeds from Johnny's Select (Winslow, ME) were sown into a flat in the greenhouse. After germination, the seeds were transplanted into four inch polystyrene Speedling (Speedling, Inc., Sun City, FL) trays in Berger BM1 growth media (Berger Peat Moss, Quebec, Canada) and grown to maturity. (*Figure A-2*) A one hundred mg/L solution of 20-9-17 (N-P-K) fertilizer was applied once a week starting three weeks after transplanting. Plants were chosen at random to undergo two leaf harvests. One harvest was performed on ten plants during the basal growth period (treatment 1). In this harvest, one small, healthy leaf between true leaf stages 3-5 was removed. The second leaf harvest of cauline leaves was performed on another twenty randomly chosen plants (treatment 2). One leaf off of the flowering stem was chosen. One plant did appear in both random leaf harvest selections. As the flowers matured, cloth, drawstring bags (10 x 15 cm; Consolidated Plastics Co., Inc., Twinsburg, OH) were placed over the seed heads

to prevent loss of seeds, as the seed heads open at maturity and seeds are dispersed via wind with the pappus attached to each seed. Mature seeds were harvested from all the plants that had experienced a leaf harvest. An additional random selection of twenty-five plants that had experienced no leaf harvesting was chosen for seed harvest (treatment 3). The seeds were harvested off the remainder of the plants and bulked. At the time of seed harvest, growth data was recorded, including stem height, mature seed weight and number, immature seed weight and number, and days to maturity. Seeds were stored at 4 C until analysis. Growth and yield parameters were analyzed using mixed model ANOVA and LSD means separation, on a complete random design (CRD) using SAS (SAS Institute, Inc., Cary, NC).

For analysis, seeds were sterilized using 70% ethanol followed by a 5% bleach/1% sodium dodecyl sulfate (SDS) solution. (*Procedure D-1*) The seeds were allowed to dry and then were ground with a coffee mill. For flavonolignan extraction, 100 mg *Silybum* seed meal was sonicated with petroleum ether for 30 min for defatting. This was followed by a triple extraction with methanol. After each methanol addition, the samples were sonicated for 20 min. The aliquots from each methanol extraction were pooled and evaporated to dryness under a nitrogen stream. Samples were then redissolved in 1.0 mL of methanol and 100 µL of 1.0 mg/mL hesperetin internal standard was added. This mixture was filtered through a 0.45 µm syringe filter into 2 ml crimp-top HPLC sample vials. (*Procedure D-2*) Extracts were analyzed for flavonolignan content with an Agilent 1100 HPLC (Agilent Technologies, Santa Clara, CA) equipped

with a diode array detector (DAD), and a Luna C-18(2) (250 x 4.6 mm, 5 μ m) column (Phenomenex, Torrance, CA) using a method adapted from Wallace et al. (2003). The column was held at 40 C. The injection volume was 25 μ L. Mobile phase A consisted of a 20:80 methanol: water solution, and mobile phase B consisted of an 80:20 methanol: water solution. The solvent gradient started with an 85:15 mixture of mobile phases A and B for 5 min. Over the next 15 min, the gradient changed linearly to 45:55 (solvent A: solvent B) and was held constant for 15 min. The ratio then changed linearly to 0:100 (solvent A: solvent B) over 3 min. This was held constant for 5 min. The gradient then changed linearly over 1 min to the original ratio of 85:15 (solvent A: solvent B) for a total run time of 44 min. (*Table B-1*) The flow rate for the gradient program was held constant at 0.8 mL/min. (*Procedure D-3*) Flavonolignan quantities are reported in mg of compound per g of seed (mg/g). (*Procedure D-4*) Mixed model ANOVA with LSD means separation, using a complete random design (CRD) with sampling, was performed using SAS to analyze flavonolignan content (SAS Institute, Inc., Cary, NC).

Initial Germination Study

Seed germination was studied due to poor germination that occurred after the preliminary experiment. Organically grown *Silybum marianum* seeds were obtained from Johnny's Select Seeds. Initial attempts at germinating seeds for subsequent studies were unsuccessful and inconsistent with the germination rate reported by the seed company. Therefore, germination techniques were studied.

A small growth chamber (Model E-30B; Percival Scientific, Perry, IA) was programmed for 16 hours of dark at 20 C and 8 hours of light (photosynthetic photon flux

of $300 \mu\text{mol m}^{-2} \text{s}^{-1}$) at 26 C. Five Petri dishes were prepared containing moistened germination paper and twenty seeds per plate. The dishes were placed in the growth chamber with the lid askew as to prevent evaporation of the water and overheating of the seeds. Another five groups of twenty seeds were subjected to a pre-chilling method as described by the Seed Lab Manager at Johnny's Select Seeds (Norma Rossel, personal communication). These plates were prepared as previously described with the addition of a one week pre-chilling period at 4 C.

A similar trial was performed on various seed sources to determine which seed source was the most reliable to use for the environmental stress experiments. Seven seed sources were obtained including the following: Johnny's Select Seeds, Frontier Natural Products Co-op (Norway, IA), Frontier Natural Products Co-op (organically grown), Wild Weeds (Blue Lake, CA) (grown in Oregon), Wild Weeds (grown in Croatia), Stony Mountain Botanicals Ltd. (Loudonville, OH), and Richters Herbs (Ontario, Canada).

Surface Sterilization Technique

Sterilization was deemed necessary after viewing the results from controlled germination. Seeds were subjected to a treatment with 5% bleach for five min washed off with water three times. The seeds were then grown on Petri dishes in the manner previously described, again comparing a pre-chilled group to a group placed directly in the growth chamber. When fungal growth was still prevalent, a more aggressive sterilization procedure was sought. The method used for the remainder of the studies involved washing the seeds for two minutes in a 70% ethanol mixture, rinsing the seeds, placing them in a 5% bleach/95%water/1% sodium dodecyl sulfate (SDS) solution for

fifteen minutes, and thoroughly rinsing the seeds with water. (*Procedure D-1*) This method was used for seeds prior to germination, as well as harvested seeds from subsequent experiments previous to grinding and analysis.

Results

Preliminary Study

Average stem height, number and weight of mature seeds per plant, and total number and weight of seeds per plant were significantly affected by leaf harvest treatments. (*Table B-2*) Average stem heights were 26.0 cm, 25.0 cm, and 32.6 cm for the basal leaf removal, the cauline leaf removal, and no leaves removed, respectively. The height of plants with no leaves removed varied significantly from the other two treatments ($P<0.05$). (*Table A-3*) Similarly, the number of mature seeds harvested from plants that had had no leaves removed was significantly greater than the two treatments where leaves were removed ($P<0.05$). Seeds counts for treatments 1, 2, and 3 were 16, 13, and 22 seeds/plant, respectively. (*Table A-4*) The weight of mature seeds for treatments 1, 2, and 3 were 0.399, 0.319, and 0.621 g/plant, respectively, with the weight of treatment 3 varying significantly ($P<0.05$). Total seed weights were 0.432, 0.340, and 0.654 g/plant, respectively. (*Table A-5*) Again, the plants that had no leaves removed were significantly different than the other two treatments ($P<0.05$).

Mixed model ANOVA analysis showed that only the levels of taxifolin were significantly affected by the leaf removal treatments. All other flavonolignans were not significantly affected by treatments. (*Table B-3*) The seed-only treatment contained 1.43

mg taxifolin/g of seed meal, while the leaf removal treatments yielded an average of 0.97 mg/g taxifolin. While the flavonolignans were not overall affected by the treatment, LSD means separation did find some significance between certain treatments.

Silychristin levels indicated a difference between seed-only harvest and basal leaf harvest ($P < 0.05$), with average concentrations of 4.48 and 3.32 mg/g, respectively. (*Figure A-6*)

Total silymarin concentrations also showed differences between seed only harvest and basal leaf harvest, with average silymarin concentrations of 30.73 and 25.19 mg/g, respectively. (*Figure A-7 and Table B-3*)

Unknown compounds 3, 4, and 7 were also significantly affected at $P < 0.05$. (*Table B-4*) For unknown 3, cauline leaf and seed only harvests were significantly greater than the basal leaf harvest. The concentration of unknown 4 was highest in the seed-only harvest and lowest in the cauline leaf harvest. Unknown 7 concentrations were highest in the cauline leaf harvest treatment and lowest in the basal leaf and seed-only harvests. (*Figure A-8 and Table B-4*)

Initial Germination Study

Seeds that were placed in the growth chamber with no pre-chilling treatment started to show signs of fungal infection within four days placement into the growth chamber. The fungi appeared to be most concentrated around the area of radicle emergence from the seed. When seeds subjected to the pre-chilling treatment were observed, fungal growth was already apparent, despite the cold conditions. Both groups showed germination. However, the prevalence of the fungal growth overtook the radicle in many cases. Germination could not be considered successful in most cases.

The germination trials performed with the seven seed sources determined that the Wild Weeds (Croatia) source demonstrated the highest level of germination and dependability. These seeds were used for all the subsequent environmental stress experiments.

Discussion

Preliminary Study

The growth and yield data from this study suggested that the removal of vegetative growth from milk thistle has significant effects on total plant growth and seed development. Possibly, these results are exaggerated in this study because of the confined growing space these plants were subjected to. From observation, these plants did not produce the amount of foliage that is typical for this plant when grown in the field or large, hydroponic bags in the greenhouse. Therefore, the removal of any vegetative growth limited the plants accumulation of photoassimilates, limiting the available resources for further growth and secondary metabolite production.

While there was no difference in the production of individual silymarin components among the treatments, the total amount of silymarin produced was significantly higher in the plants with no leaves removed than the plants that had a basal leaf removed. This suggested that early removal of vegetative material significantly affected that amount of flavonolignans that were yielded at seed maturity.

Initial Germination Study

Milk thistle is a weedy species, and one successful trait that many weeds possess is sporadic germination. This allows for stronger success for a wild population to reproduce to the next generation, as the entire seed bank is not destroyed by one devastating event, such as a severe drought. (Dodd, 1989; Groves and Kaye, 1989) Milk thistle is also known to germinate at a much lower rate soon after the seeds reach maturity. After a “curing” period of usually 3-6 months, germination improves. Actual age of the seeds from various sources was unknown, therefore, the possibility remains that the seeds had not yet reached their maximum potential for germination.

Furthermore, the seeds from Johnny’s Select that were used in the initial leaf harvest study had been in cool storage since 2001, so it stands to reason that these seeds were indeed more prepared to germinate than newer seeds also obtained from Johnny’s Select as well as other seed sources.

Initial germination studies were riddled with fungal problems and poor germination. Surface sterilization was a partial cure for the fungal problem. However, seeds still did not germinate when given recommended light and moisture recommendations. The probability exists that these seeds were still not physiologically mature enough to achieve high germination rates or the fungi had weakened seed viability.

IV. Flavonolignan Content of Various Seed Sources

Abstract

Flavonolignan in milk thistle have been shown to vary depending on the climate in which the plants were grown and genetic diversity within a population. This study looked at the silymarin levels in seeds from eight seed sources from around the world. Tested seeds were grown in Oregon, Croatia, Serbia, and various parts of the midwest United States and Europe. All flavonolignans were significantly different in each seed source. Total silymarin concentrations ranged from 56.9 mg/g of seed meal in seeds from Stony Mountain Botanicals to 29.6 mg/g of seed meal in seeds from Johnny's Selected Seeds.

Introduction

The levels of flavonolignans in *Silybum* have been shown to differ when plants are grown in varying climates (Kurkin, 2003). Seeds were obtained from eight different seed sources around the world. Geographic areas covered include the midwest United States, Oregon, Croatia, Serbia, and Europe. Samples from each of the seed sources were extracted and analyzed by HPLC to observe the differences in silymarin profiles from each geographic area.

Materials & Methods

Seeds were obtained from Frontier Natural Products Co-op (organically and non-organically grown lots), Johnny's Select Seeds, Wild Weeds (seeds lots grown in Croatia

and Oregon), University of Belgrade, Stony Mountain Botanicals, Ltd., and Richters Herbs. Seeds were sterilized, ground to 20 mesh, extracted once with petroleum ether for defatting, and extracted in triplicate with methanol for flavonolignan analysis.

(Procedures D-1 – D-4) Analysis was performed on an Agilent 1100 HPLC equipped with a DAD detector as detailed in Chapter III. Flavonolignan levels were statistically analyzed in a CRD using mixed model ANOVA and Tukey means separation.

Results

All silymarin components and unknown compounds were significantly affected by the seed source. *(Table B-5 and B-6)* Tukey means separation did show differences in compounds between seed sources. *(Figure A-9)* Seeds obtained from Stony Mountain Botanicals, Ltd. (SM) and Frontier Natural Products Co-op (F) yielded the highest total silymarin concentration at 56.90 and 51.41 mg/g of seed meal, respectively. The lowest concentration of 29.6 mg/g silymarin was found in the seeds from Johnny's Select Seeds. *(Figure A-11)* Varying seed sources also had different flavonolignan profiles. *(Figure A-10)* The silymarin profiles of SM and F seeds also had the highest concentrations of silybin A & B.

Discussion

This analysis confirms the great variability in flavonolignan content that exists in milk thistle plants. Kurkin (2003) speaks of milk thistle grown in Yugoslavia, Bulgaria, various parts of Russia, Hungary, and Sweden varying in the ratios of individual

flavonolignans in the silymarin complex. Seeds from plants grown in Russia had a 3:1 ratio of silybin to silydianin. Seeds harvested in Yugoslavia had 10:4:1 ratio of silybin to silydianin to silychristin. Silydianin was the primary compound in seeds grown in Ukraine. Plants from Sweden also had higher concentrations of silydianin than silybin.

In this seed source analysis, the SM and F seed sources contained the highest total silymarin content as well as the highest content of silybin A & B. Silybin is commonly regarded as the most bioactive constituent of silymarin (Crocenzi and Roma, 2006). However, silydianin was present in the highest concentrations across all seed sources analyzed here. Some of the sources, like Frontier Natural Products Co-op, sell milk thistle seeds for dietary supplementation, not necessarily for reproduction of the plant. This reiterates the importance in quality control in herbs when growing plants for medicinal extracts.

V. Population Density Effects on Growth, Yield, and Flavonolignan Production

Abstract

Milk thistle, *Silybum marianum* (L.) Gaertn., is grown throughout the world for its hepatoprotectant flavonolignans, known collectively as silymarin. Silymarin is found primarily in the seeds. Milk thistle was grown in a controlled environment (16 hours of light at 1200 $\mu\text{mol}/\text{m}^2/\text{s}$ and 23 C and 8 hours of dark at 16 C) for determination of plant growth, seed yield, and flavonolignan content under various levels of population density stress (ranging from 1 to 24 plants per container). Total seed count per plant (ranging from 0-293) and yield (ranging from 0.0-4.3 g) decreased with increasing population density; furthermore, the count and yield of malformed or immature seed also decreased with increasing density. Additionally, the number of blooms per plant, bloom diameter, and mature seed count and yield were negatively correlated to density. There was no significant effect of population density on flavonolignan content.

Introduction

Milk thistle is a medicinal plant whose use has been documented since ancient times as a treatment for liver and bile-related diseases, as well as acute *Amanita* mushroom poisoning (Fraschini et al., 2002; Kurkin, 2003). Current studies have explored milk thistle's use against various types of cancer, for cholesterol control, and for blood sugar control in those with type II diabetes (Gazak et al., 2007; Huseini et al.,

2006). Many of these benefits are attributed to the phenolic content of the plant's leaves and seeds, which, like many secondary metabolites, are known to be affected by biotic and abiotic stress (Beckman, 2000; Sudha and Ravishankar, 2002). The seeds contain a group of hepatoprotectant phenolic compounds known as flavonolignans.

Flavonolignans are formed from a coupling of a flavonoid, taxifolin (dihydroquercetin), and a phenylpropanoid lignan component, coniferyl alcohol. The primary bioactive flavonolignans include silybin A, silybin B, isosilybin A, isosilybin B, silychristin, and silydianin. These compounds, along with taxifolin comprise the hepatoprotectant complex called silymarin.

Since these valuable medicinal compounds are found primarily in the seeds, factors regulating seed production in milk thistle crops are important. The relationship among blooms (or heads) and seed weight and count were described by Gabucci et al. (2002). The number of seeds per plant was positively correlated to the number of heads per plant. The weight of the seeds per plant was positively correlated to the number of heads per plant, the number of seeds per head, and the individual seed weight. In addition, the number of seeds per head increased with bloom diameter and decreased with the number of heads per plant.

Population density and row spacing have been shown to have significant effects on the growth, yield, and flavonolignan concentrations in milk thistle. Austin et al. (1988) showed that milk thistle harvested 6 weeks after planting had the highest shoot yield when planted at a density of 8 plants/pot (pot diameter = 18 cm). At the next

density of 16 plants/pot, shoot yield began to decrease. Omer et al. (1993) found that a narrow row spacing of 25 cm produced higher seed yields in milk thistle but lower oil and flavonolignan content compared to a wide row spacing of 50 cm. Concentrations of silybin, silychristin, isosilybin, and silymarin were all significantly higher in the wider row spacing than the 25 cm row spacing.

The objectives of this experiment were three-fold. The first was to examine the effect of population density on plant growth and seed yield of milk thistle. The second was to determine if population density stress affects the quality and quantity of silymarin in the seeds, and the third was to determine an optimum population density for seed and flavonolignan yield.

Materials & Methods

Plants were grown in 19 L (0.02 m³) poly grow bags (Hydro-Gardens, Colorado Springs, CO) in pine bark media (SunGro Horticulture, Bellvue, WA) with 15 mL (15.67 g) 14-6-12 (N-P-K) Osmocote (Scotts-Sierra Horticultural Products Co., Marysville, OH). Population density treatments were based on the number of seedlings planted per bag. Densities were 1, 2, 4, 8, 12, 16, 20 and 24 plants per bag. Bags were arranged in a randomized complete block (RCB) design consisting of two blocks with each treatment represented once per block. (*Figures A-12 and A-13*) The plants were grown to maturity in a growth chamber with 16 hours of light at 1200 $\mu\text{mol}/\text{m}^2/\text{s}$ and 23 C and 8 hours of dark at 16 C. Blooms were covered with drawstring bags post-anthesis. At maturity the blooms were harvested, and growth data including blooms per plant, bloom diameter,

days to maturity, stem height, mature and immature seed number and weight were collected (*Figure A-14*). Seed were stored at 4 C until analysis.

Seed preparation and analysis was performed as detailed in Chapter III. (*Procedures D-1 – D-4*) Growth and yield data, as well as flavonolignan and unknown compound concentrations were analyzed using simple linear regression, with the exception of bloom diameter which was analyzed with quadratic regression. Statistical analysis was performed using SAS.

Results

All regression analyses were calculated using the actual numbers of plants harvested in each container. Mortality was high in some of the original planned treatment densities, which resulted in different numbers of plants per container (*Table B-7*). Analysis showed a normal distribution of all growth and yield parameters against the treatments. The number of blooms per plant ($R^2=0.43$), bloom diameter ($R^2=0.59$), number and weight of mature seeds ($R^2=0.54$ and $R^2=0.53$, respectively), number and weight of immature seeds ($R^2=0.43$ and $R^2=0.29$) and total number and weight of seeds ($R^2=0.62$ and $R^2=0.55$, respectively) were negatively correlated to plant density ($P<0.05$). (*Figures A-15 – A-18*) All components of silymarin (taxifolin, silychristin, silydianin, silybin A and B, and isosilybin A and B) and unknown compounds were normally distributed. However, none were significantly affected by population densities. (*Table B-8 & B-9*) Total levels of silymarin in seeds varied with population density, but not significantly (*Figure A-19*).

Discussion

From this study it was concluded that increasing population density did not affect the quantity and quality of flavonolignans. Decreased yield and overall plant vigor occurred when milk thistle was grown in high density conditions. The decreased seed yields and numbers were consistent with lower bloom diameters and number of blooms per plant, as was previously described by Gabucci et al. (2002). However, these findings disagree with seed yields and flavonolignan effects reported by Omer et al. (1993). Further research in this area could include population density effects in a field setting where root growth is not as restricted as in this experiment, and plants are exposed to sunlight as opposed to artificial light.

VI. Daily Water Rate Effects on Growth, Yield, and Flavonolignan Production

Abstract

Milk thistle, *Silybum marianum* (L.) Gaertn., is a medicinal plant, grown worldwide, that contains hepatoprotectant phenolic compounds known as flavonolignans. These compounds are found primarily in the seeds and are collectively known as silymarin. This study examined the effects of water stress on plant growth, seed yield, and flavonolignan content in milk thistle. Plants were hydroponically grown under greenhouse conditions with varying daily water rates (200, 650, 1100, 1550, and 2000 mL/day). The lowest watering rate significantly reduced stem height (40.8 cm) and bloom diameter (2.3 cm). The 1550 mL/day treatment had the highest stem height at 106.3 cm, and the 1100 mL/day treatment had the largest bloom diameter at 2.9 cm. The highest water treatment also showed the highest count of malformed or immature seeds (161 seeds/plant). The 650 mL/day treatment had the lowest number of immature seeds with 62 seeds/plant. The primary blooms were analyzed separately from the secondary blooms for flavonolignan content. In primary blooms, the lowest water rate yielded the highest concentration of taxifolin (0.89 mg/g of seed meal). In secondary blooms, flavonolignan content was not significantly affected.

Introduction

Milk thistle grows worldwide and its use has been documented since ancient times as a treatment for liver and bile-related diseases, as well as acute *Amanita* mushroom poisoning (Fraschini et al., 2002; Kurkin, 2003). In addition to antihepatotoxic actions, current studies have explored milk thistle's use against various types of cancer, for cholesterol control, and for blood sugar control in those with type II diabetes (Gazak et al., 2007; Huseini et al., 2006). The phenolic content of the plant's leaves and seeds have been associated with these benefits. Like many secondary metabolites, phenolics are known to be affected by biotic and abiotic stress (Beckman, 2000; Sudha and Ravishankar, 2002). Concentrated in the seeds are a group of hepatoprotectant phenolic compounds known as flavonolignans. Flavonolignans are formed from the coupling of a flavonoid, taxifolin (dihydroquercetin), and a phenylpropanoid lignan component, coniferyl alcohol. The primary bioactive flavonolignans include silybin A, silybin B, isosilybin A, isosilybin B, silychristin, and silydianin. These compounds, along with taxifolin, comprise the hepatoprotectant complex known as silymarin.

Silymarin levels have been documented to be affected by water availability. Hammouda et al. (1993) showed that silymarin levels were higher in plants grown at 60% field capacity compared to wild harvested plants. Silydianin also decreased in plants grown under lower water conditions.

The objectives of this study were: 1) to examine the effects of water stress on plant growth and seed yield of milk thistle and the quality and quantity of silymarin in the seeds; and 2) to determine the irrigation rate needed to optimize seed yield and flavonolignan content.

Materials & Methods

This experiment was conducted in the greenhouse in 0.02 m³ poly grow bags (Hydro-Gardens, Colorado Springs, CO) filled with perlite. Plants, planted one per bag, were subjected to five different watering regimes. This experiment was set up in a randomized complete block (RCB) with four blocks to account for variation across the greenhouse. Each block contained two single plant replications of each of the five watering treatments. (*Figure A-20*) The treatments were controlled using spray irrigation emitters of different rates. There was also an emitter in each bag that emitted a fertigation solution at a rate of 100 mL/day. The fertigate was a mixture of 25% Chem-Gro 4-8-31 (N-P-K) (Hydro-Gardens, Inc., Colorado Springs, CO), 25% fertilizer grade CaNO₃, and 12.5% MgSO₄. (*Table B-10*) This mixture was further diluted with water to a ratio of 1:100 using fertilizer injectors. Plants received 10.2 mg of nitrogen, 4.09 mg of phosphorus, and 16.4 mg of potassium per day. The watering rates were as follows: 2000, 1550, 1100, 650 and 200 mL/day (these rates include 100 mL of fertigation per day). The plants grew and developed in this hydroponic system until flowering. (*Figure A-21*) Cloth, drawstring bags were placed over the blooms as post-anthesis. At maturity the blooms were harvested, and growth data including blooms per plant, bloom diameter,

days to maturity, stem height, mature and immature seed number and weight were collected. Primary blooms from each plant were analyzed separately from all secondary blooms. Secondary blooms were grouped together from each plant for analysis. Seeds were stored at 4 C until analysis.

Seeds were sterilized before starting extractions and analysis. (*Procedure D-1*)

Extraction and analysis was performed as detailed in Chapter III. (*Procedures D-2 – D-4*)

Statistical analysis was performed using SAS. Growth and yield data, as well as flavonolignan and unknown compound concentrations were analyzed using mixed model ANOVA and LSD means separation. SAS was used for all statistical analyses.

Results

Growth and yield data were analyzed using a RCB with replication model.

Parameters of bloom diameter, stem height, and count of immature seeds were significantly affected by water treatments according to LSD means separation ($P < 0.05$). Bloom diameter was smallest, at an average of 2.3 cm, in the 200 mL/day treatment and greatest in the 1100 mL/day treatment, with an average of 2.9 cm. The other treatments did not change bloom diameter significantly from the 1100 mL/day treatment. (*Figure A-23*) Stem height was significant in the ANOVA analysis ($P = 0.0005$) as well as mean separation. Stems were shortest, at 40.8 cm, in the 200 mL/day treatment. The 650 and 2000 mL/day were statistically the same with an average stem height of 71.5 cm. The 1100 and 1550 mL/day treatments were also statistically the same with an average height of 123.3 cm. (*Figure A-22 & Table B-12*) The immature seed count was also affected by

water treatments. The 2000 mL/day treatment was significantly different from the 1550 and 650 mL/day treatment (averages were 161 and 63 immature seeds per plant, respectively). The other treatments did not differ and had an average of 84 immature seeds per plant. (Figure A-24) Yield data was not significant. (Table B-11)

Primary and secondary blooms were analyzed for flavonolignan content using a RCB with replication and sampling. In primary blooms, taxifolin concentrations were significantly affected with the highest concentration (0.89 mg/g) in the 200 mL/day treatment and the lowest concentration (0.47 mg/g) in the 650 mL/day treatment. The other treatments did not differ significantly from each other and had an average taxifolin concentration of 0.64 mg/g. (Figure A-25) Water level did not significantly affect flavonolignans in secondary blooms. Water level did not significantly influence silymarin content in primary or secondary blooms. (Figures A-26 and A-27)

Discussion

Plant growth and secondary metabolite concentrations have been documented to be affected by water stress. In a study of Japanese mint (*Mentha arvensis*), researchers found that water stress, from unstressed levels to acute stress levels, reduced plant height (51.5 to 39.7 cm, respectively) and leaf length (4.8 to 3.5, respectively). Terpenoid essential oil levels (menthol, menthone, and methyl acetate) were highest at mild stress levels (30% field moisture capacity) at 0.58% fresh weight. Essential oil levels were significantly lowered by acute water stress (10% field moisture capacity) to 0.40% fresh weight. (Misra and Srivastava, 2000)

From this study it was concluded that different daily water rates has minimal effect on the quantity and quality of flavonolignans in milk thistle. The minor growth differences observed between treatments and the lack of effect on days for plants to reach maturity suggest that conditions of true water stress were not reached in this experiment. Cell growth has been determined to be the first process that declines when a plant undergoes water stress. Closely related to growth in being restricted by water stress is cell division. (Hsiao et al., 1976) These processes were slowed in the lowest water treatment, as stem height and bloom diameter were affected. While the lowest water rate did affect stem height and bloom diameter, it had no effect on mature seed count or yield. Therefore, the lowest water treatment did not have a major effect on overall plant vigor. The results indicated that milk thistle can be grown with minimal input of water without decreasing yield or flavonolignan content.

Furthermore, the literature suggests that milk thistle is not susceptible to many insect and disease pressures in field production. While this may be true, in greenhouse production insect pressure was great. White flies and aphids were both troublesome. (Figure A-28)

VII. Summary & Overall Conclusions

Flavonolignan Content

Growth and yield of milk thistle was affected, typically reduced, with increasing stress. However, flavonolignan concentrations were largely unaffected by environmental stresses studied here. From a production standpoint, flavonolignan content per plant or per unit area may be a more useful calculation. Despite reduction in overall growth or yield, silymarin content produced per unit area (in these experiments unit area = $4 \text{ ft}^2 = 0.37 \text{ m}^2$) may be increased.

When silymarin content was calculated for the preliminary experiment with the data from the three leaf removal treatments, basal leaf removal yielded $362 \text{ mg}/4 \text{ ft}^2$. Cauline leaf removal yielded $334 \text{ mg}/4 \text{ ft}^2$, and the plants with no leaves removed yielded $687 \text{ mg}/4 \text{ ft}^2$. These plants were grown in 4" Speedling trays, therefore, a 4 ft^2 area represents 36 plants.

In the population density study, flavonolignan content varied from $29.0 \text{ mg}/\text{bag}$ (6 plants/bag) to $285 \text{ mg}/\text{bag}$ (12 plants/bag). The median content was $147 \text{ mg}/\text{bag}$ (11 plants/bag). Each bag represents roughly 4 ft^2 (this includes the bag diameter of 1 ft plus 1 ft spacing between bags).

Content calculations for the water experiment resulted in the following results: 200 mL/day had $204 \text{ mg}/\text{bag}$, 650 mL/day had $238 \text{ mg}/\text{bag}$, 1100 mL/day had $530 \text{ mg}/\text{bag}$, 1550 mL/day had $585 \text{ mg}/\text{bag}$, and 2000 mL/day had $391 \text{ mg}/\text{bag}$. Again, each bag plus spacing between bags is 4 ft^2 .

In the water stress experiment, the time from planting to harvest was approximately one year. The preliminary experiment reached maturity in approximately four months. If milk thistle plants grown in small containers could be harvested every four months, it would be possible to reach a total silymarin yield of 2061 mg/4 ft²/year. This surpasses the yield potential of plants under any of the water stress treatments.

Other Considerations

UV Light

Flavonolignans in milk thistle were not significantly affected by population density or water stress. Several concepts may explain the lack of significant effects. Flavonolignans may function in the plant to protect from UV radiation. In human keratinocytes, silymarin has shown to reduce UVA-induced damage by reducing the amount of reactive oxygen species formed and reducing lipid peroxidation. (Svobodova et al., 2007) Silymarin could function in similar ways in plant cells as well. To study population density and water stress, plants were grown in greenhouses and growth chambers. Neither of these controlled environments have high incidence of UV light. The absence of UV light may have reduced the amount of flavonolignans formed.

Conjugated Flavonolignans

Warren (2003) found bioactivity in milk thistle roots, stems, and leaves in the potato disk bioassay, but CE analysis did not detect pure flavonolignan compounds in these vegetative extracts. Other studies have found that flavonolignans can be compounded with carbohydrate or lipid compounds. Synthesized silybin glycosides have

shown to have strong antioxidant properties on hepatocytes in culture, although antioxidant capacity was reduced compared to that of silybin. However, overall solubility and bioavailability was greater in the glycosides than in the pure compound. (Kosina et al., 2002) Flavonolignan glycosides may exist in the roots, stems, and leaves of milk thistle. The improved solubility of the flavonolignan glycosides could improve compound mobility in the plant and could concentrate in areas experiencing stress.

Similarly, flavonolignans may exist in lipid forms. Studies have shown that flavonolignans coupled with phosphatidylcholine, a phospholipid, improved bioavailability in the body. (Kidd and Head, 2005) Flavonolignans have also been shown to stabilize cell membranes in the liver to prevent the entrance of toxins into liver cells. (Fraschini et al., 2002) A similar action could occur in milk thistle cell membranes as well, preserving membrane integrity in occurrence of stress. Unsaturated phospholipids in cell membranes can be easily oxidized. Therefore, a lipid-bound flavonolignan could interact with and provide antioxidant effects directly to the cell membrane.

Both of these proposed flavonolignan forms could exist in the plant and provide an explanation of the role of flavonolignans in the plant. If these compounds did exist in vegetative tissue, milk thistle could be grown for a short time in the basal stage, and then vegetative growth could be bulk-harvested for flavonolignan extraction. This would shorten the time between planting and harvesting to obtain the beneficial compounds.

Further Research

Further research should include antioxidant screenings of both lipid- and water-soluble fractions of milk thistle vegetative tissue. Also, a study should examine potential

differences in flavonolignan profiles in plants grown in a controlled environment to those grown in the field where UV light radiation would be high. These experiments would greatly benefit flavonolignan production for medicinal use as well as propose a role for flavonolignans within the milk thistle plant.

Literature Cited

- Abebe, W. 2002. Herbal medication: potential for adverse interactions with analgesic drugs. *J. Clin. Pharm. Ther.* 27: 391-401.
- Ahmed, E., A.T. Noor, A. Malik, S. Ferheen, and N. Afza. 2007. Structural determination of silymins A and B, new pentacyclic triterpenes from *Silybum marianum*, by 1D and 2D NMR spectroscopy. *Magn. Reson. Chem.* 45: 79-81.
- Andrzejewska, J., R. Lamparski, and Z. Skinder. 2006. Assessing the extent of damage caused by *Cleonus piger* Scop. and other entomofauna in the cultivation of milk thistle [*Silybum marianum* (L.) Gaertn.]. *J. Plant Protect. Res.* 46: 49-59.
- Auld, B.A. and R.W. Medd. 1987. *Weeds. An Illustrated Botanical Guide to the Weeds of Australia.* Inkata Press, Melbourne.
- Austin, M.P., L.F.M. Fresco, A.O. Nicholls, R.H. Groves, and P.E. Kaye. 1988. Competition and relative yield - estimation and interpretation at different densities and under various nutrient concentrations using *Silybum marianum* and *Cirsium vulgare*. *J. Ecol.* 76: 157-171.
- Ball, K.R. and K.V. Kowdley. 2005. A review of *Silybum marianum* (milk thistle) as a treatment for alcoholic liver disease. *J. Clin. Gastroenterol.* 39: 520-528.

Barnes, J. 2003. Pharmacovigilance of Herbal Medicines: A UK Perspective. *Drug Safety*. 26: 829-851.

Barreto, J.F.A., S.N. Wallace, D.J. Carrier, and E.C. Clausen. 2003. Extraction of nutraceuticals from milk thistle I. Hot water extraction. *Appl. Biochem. Biotech.* 105: 881-889.

Bean, C. 1985. Element stewardship abstract for *Silybum marianum*.

Beckman, C.H. 2000. Phenolic-storing cells: keys to programmed cell death and periderm formation in wilt disease resistance and in general defence responses in plants? *Physiol. Mol. Plant P.* 57: 101-110.

Bergeron, C., A. Marston, R. Gauthier, and K. Hostettmann. 1996. Screening of plants used by North American Indians for antifungal, bactericidal, larvicidal, and molluscicidal activities. *Int. J. Pharmacogn.* 34: 233-242.

Bilia, A.R., M.C. Bergonzi, S. Gallori, G. Mazzi, and F.F. Vincieri. 2002. Stability of the constituents of Calendula, Milk-thistle and Passionflower tinctures by LC-DAD and LC-MS. *J. Pharmaceut. Biomed.* 30: 613-624.

- Bilia, A.R., D. Salvini, G. Mazzi, and F.F. Vincieri. 2001. Characterization of calendula flower, milk-thistle fruit, and passion flower tinctures by HPLC-DAD and HPLC-MS. *Chromatographia*. 53: 210-215.
- Borchers, A.T., C.L. Keen, J.S. Stern, and M.E. Gershwin. 2000. Inflammation and Native American medicine: the role of botanicals. *Am. J. Clin. Nutr.* 72: 339-347.
- Bourgaud, F., A. Gravot, S. Milesi, and E. Gontier. 2001. Production of plant secondary metabolites: a historical perspective. *Plant Sci.* 161: 839-851.
- Brevoort, P. 1996. The U.S. botanical market - an overview. *HerbalGram*. 36: 49-58.
- Camel, V. 2001. Recent extraction techniques for solid matrices-supercritical fluid extraction, pressurized fluid extraction and microwave-assisted extraction: their potential and pitfalls. *Analyst*. 126: 1182-1193.
- Carrier, D.J., T. Crowe, S. Sokhansanj, J. Wahab, and B. Barl. 2002. Milk thistle, *Silybum marianum* (L.) Gaertn., flower head development and associated marker compound profile. *J. Herbs Spices Med. Plants*. 10: 65-74.
- Chaterji, R., R.E. Tractenberg, H. Amri, M. Lumpkin, S.B.W. Amorosi, and A. Haramati. 2007. A large-sample survey of first- and second year medical student attitudes

toward complementary and alternative medicine in the curriculum and in practice. *Alt. Ther. Health Med.* 13: 30-35.

Crocenzi, F.A. and M.G. Roma. 2006. Silymarin as a new hepatoprotective agent in experimental cholestasis: New possibilities for an ancient medication. *Curr. Med. Chem.* 13: 1055-1074.

Danin, A. and Y. Yom-Tov. 1990. Ant nests as primary habitats of *Silybum marianum* (*Compositae*). *Pl. Syst. Evol.* 169: 209-217.

Deep, G., R.P. Singh, C. Agarwal, D.J. Kroll, and R. Agarwal. 2006. Silymarin and silibinin cause G1 and G2-M cell cycle arrest via distinct circuitries in human prostate cancer PC3 cells: a comparison of flavanone silibinin with flavanolignan mixture silymarin. *Oncogene.* 25: 1053-1069.

Dillard, C.J. and J.B. German. 2000. Phytochemicals: nutraceuticals and human health. *J. Sci. Food Agric.* 80: 1744-1756.

Dingwall, A.R. 1950. Variegated thistle and its control. *New Zeal. J. Agr.* 81: 141-142.

- Dodd, J. 1989. Phenology and seed production of variegated thistle, *Silybum marianum* (L.) Gaertn., in Australia in relation to mechanical and biological control. Weed Res. 29: 255-263.
- Earnest, C. 2005. Natural compounds to protect the liver. Funct. Foods Nutraceut.
- Elvin-Lewis, M. 2001. Should we be concerned about herbal remedies. J. Ethnopharmacol. 75: 141-164.
- Ernst, E. 2002. The risk-benefit profile of commonly used herbal therapies: ginkgo, St. John's wort, ginseng, echinacea, saw palmetto, and kava. Ann. Intern. Med. 136: 42-53.
- Feher, J., D. G., G. Muzes, L. I., N. V., and N. K. 1989. Liver-protective action of silymarin therapy in chronic alcoholic liver diseases [Hungarian]. Orv Hetil. 130: 2723-2727.
- Flora, K., M. Hahn, H. Rosen, and K. Benner. 1998. Milk thistle (*Silybum marianum*) for the therapy of liver disease. Am. J. Gastroenterol. 93: 139-143.
- Fraschini, F., G. Demartini, and D. Esposti. 2002. Pharmacology of silymarin. Clin. Drug Invest. 22: 51-65.

- Gabay, R., U. Plitmann, and A. Danin. 1994. Factors affecting the dominance of *Silybum marianum* L. (Asteraceae) in its specific habitats. *Flora*. 189: 201-206.
- Gabucci, L., A. Curioni, M. Garcia, and M.E. Urrutia. 2002. Seeds production in milk thistle crop. *Acta Hort*. 569: 121-128.
- Gazak, R., D. Walterova, and V. Kren. 2007. Silybin and silymarin - New and emerging applications in medicine. *Curr. Med. Chem*. 14: 315-338.
- Grabowicz, M., P. Dorszewski, P. Szterk, J. Mikolajczak, and J. Pilat. 2004. Influence of whole crop milk thistle silage on cows' metabolism in a transition period. *Medycyna Weterynaryjna*. 60: 759-762.
- Groves, R.H. and P.E. Kaye. 1989. Germination and phenology of seven introduced thistle species in southern Australia. *Aust. J. Bot*. 37: 351-359.
- Hadacek, F. 2002. Secondary metabolites as plant traits: current assessment and future perspectives. *Crit. Rev. Plant Sci*. 21: 273-322.
- Hamburger, M. and K. Hostettmann. 1991. Bioactivity in plants - the link between phytochemistry and medicine. *Phytochemistry*. 30: 3864-3874.

- Hetz, E., R. Liersch, and O. Schieder. 1995. Genetic investigations on *Silybum marianum* and *S. eburneum* with respect to leaf color, outcrossing ratio, and flavonolignan composition. *Planta Med.* 61: 54-57.
- Hoh, C., D. Boocock, T. Marczylo, R. Singh, D.P. Berry, A.R. Dennison, D. Hemingway, A. Miller, K. West, S. Euden, G. Garcea, P.B. Farmer, W.P. Steward, and A.J. Gescher. 2006. Pilot study of oral silibinin, a putative chemopreventive agent, in colorectal cancer patients: Silibinin levels in plasma, colorectum, and liver and their pharmacodynamic consequences. *Clin. Cancer Res.* 12: 2944-2950.
- Hostettmann, K. and A. Marston. 2002. Twenty years of research into medicinal plants: results and perspectives. *Phytochem. Rev.* 1: 275-285.
- Hsiao, T.C., E. Acevedo, E. Fereres, and D.W. Henderson. 1976. Stress metabolism: Water stress, growth, and osmotic adjustment. *Phil. Trans. R. Soc. Lond.* 273: 479-500.
- Huie, C.W. 2002. A review of modern sample-preparation techniques for the extraction and analysis of medicinal plants. *Anal. Bioanal. Chem.* 373: 23-30.
- Huseini, H.F., B. Larijani, R. Heshmat, H. Fakhrzadeh, B. Radjabipour, T. Toliat, and M. Raza. 2006. The efficacy of *Silybum marianum* (L.) Gaertn. (silymarin) in the

treatment of type II diabetes: a randomized, double-blind, placebo-controlled, clinical trial. *Phytother. Res.* 20: 1036-1039.

Izzo, A.A. and E. Ernst. 2001. Interactions between herbal medicines and prescribed drugs - a systematic review. *Drugs.* 61: 2163-2175.

Jacobs, B.P., C. Dennehy, G. Ramirez, J. Sapp, and V.A. Lawrence. 2002. Milk thistle for the treatment of liver disease: A systematic review and meta-analysis. *Am. J. Med.* 113: 506-515.

Kidd, P. and K. Head. 2005. A review of the bioavailability and clinical efficacy of milk thistle phytosome: a silybin-phosphatidylcholin complex (Siliphos). *Altern. Med. Rev.* 10: 193-203.

Kim, N.C., T.N. Graf, C.M. Sparacino, M.C. Wani, and M.E. Wall. 2003. Complete isolation and characterization of silybins and isosilybins from milk thistle (*Silybum marianum*). *Org. Biomol. Chem.* 1: 1684-1689.

Kittur, S., S. Wilasrusmee, W.A. Pedersen, M.P. Mattson, K. Straube-West, C. Wilasrusmee, B. Jubelt, and D.S. Kittur. 2002. Neurotrophic and neuroprotective effects of milk thistle (*Silybum marianum*) on neurons in culture. *J. Mol. Neurosci.* 18: 265-269.

- Kosina, P., V. Kren, R. Gebhardt, F. Grambal, J. Ulrichova, and D. Walterova. 2002. Antioxidant properties of silybin glycosides. *Phytother. Res.* 16: S33-S39.
- Kurkin, V.A. 2003. Saint-Mary Thistle: A source of medicinals (a review). *Pharm. Chem. J.* 37: 189-202.
- Kurkin, V.A., G.G. Zapesochaya, A.V. Volotsueva, E.V. Avdeeva, and K.S. Pimenov. 2001. Flavolignans of *Silybum marianum* fruit. *Chem. Nat. Compd.* 37: 315-317.
- Lang, Q.Y. and C.M. Wai. 2001. Supercritical fluid extraction in herbal and natural product studies - a practical review. *Talanta.* 53: 771-782.
- Lee, D.Y.W. and Y.Z. Liu. 2003. Molecular structure and stereochemistry of silybin A, silybin B, isosilybin A, and isosilybin B, isolated from *Silybum marianum* (milk thistle). *J. Nat. Prod.* 66: 1171-1174.
- Li, L.H., L.J. Wu, B. Zhou, Z. Wu, S. Tashiro, S. Onodera, F. Uchiumi, and T. Ikejima. 2004. Silymarin prevents UV irradiation-induced A375-S2 cell apoptosis. *Biol. Pharm. Bull.* 27: 1031-1036.
- Mann, R. and E. Andrews. 2002. *Pharmacovigilance*. Wiley, Chicester.

- Martin, R.J., D.R. Lauren, W.A. Smith, D.J. Jensen, B. Deo, and J.A. Douglas. 2006. Factors influencing silymarin content and composition in variegated thistle (*Silybum marianum*). *New Zeal. J. Crop Hort.* 34: 239-245.
- McKenna, D.J., K. Jones, and K. Hughes. 2002. *Botanical medicines: the desk reference for major herbal supplements*. Haworth Press, New York.
- Misra, A. and N.K. Srivastava. 2000. Influence of water stress on Japanese mint. *J. Herbs Spices Med. Plants.* 7: 51-58.
- Morazzoni, P. and E. Bombardelli. 1995. *Silybum marianum (Carduus marianus)*. *Fitoterapia.* 66: 3-42.
- Omer, E.A., A.M. Refaat, S.S. Ahmed, A. Kamel, and F.M. Hammouda. 1993. Effect of spacing and fertilization on the yield and active constituents of milk thistle, *Silybum marianum*. *J. Herbs Spices Med. Plants.* 1: 17-23.
- Osuchowski, M.F., V.J. Johnson, Q.R. He, and R.P. Sharma. 2004. Alterations in regional brain neurotransmitters by silymarin, a natural antioxidant flavonoid mixture, in BALB/c mice. *Pharm. Biol.* 42: 384-389.

- Pares, A., R. Planas, M. Torres, J. Caballeria, J.M. Viver, D. Acero, J. Panes, J. Rigau, J. Santos, and J. Rodes. 1998. Effects of silymarin in alcoholic patients with cirrhosis of the liver: results of a controlled, double-blind, randomized and multicenter trial. *J. Hepatol.* 28: 615-621.
- Pawliszyn, J. 1993. Kinetic-model of supercritical fluid extraction. *J. Chromatogr. Sci.* 31: 31-37.
- Phillipson, J.D. 2003. 50 years of medicinal plant research - every progress in methodology is a progress in science. *Planta Med.* 69: 491-495.
- Polyak, S.J., C. Morishima, M.C. Shuhart, C.C. Wang, Y. Liu, and D.Y.W. Lee. 2007. Inhibition of T-cell inflammatory cytokines, hepatocyte NF-kB signaling, and HCV infection by standardized silymarin. *Gastroenterology.* 132: 1925-1936.
- Salmi, H.A. and S. Sarna. 1982. Effect of silymarin on chemical, functional, and morphological alterations of the liver - a double-blind controlled-study. *Scand. J. Gastroentero.* 17: 517-521.
- Sartor, L.L. and L.A. Trepanier. 2003. Rational pharmacologic therapy of hepatobiliary disease in dogs and cats. *Comp. Cont. Educ. Pract.* 25: 432-446.

- Sindel, B.M. 1991. A review of the ecology and control of thistles in Australia. *Weed Res.* 31: 189-201.
- Singh, B., T.K. Bhat, and B. Singh. 2003. Potential therapeutic applications of some antinutritional plant secondary metabolites. *J. Agr. Food Chem.* 51: 5579-5597.
- Singh, J.P., B.K. Kapahi, and Y.K. Sarin. 1982. Ecology of *Silybum marianum* Gaertn.--a medicinal plant. *J. Econ. Tax. Bot.* 3: 665-668.
- Skottova, N., L. Kazdova, O. Oliyarnyk, R. Vecera, L. Sobolova, and J. Ulrichova. 2004. Phenolics-rich extracts from *Silybum marianum* and *Prunella vulgaris* reduce a high-sucrose diet induced oxidative stress in hereditary hypertriglyceridemic rats. *Pharmacol. Res.* 50: 123-130.
- Skottova, N. and V. Krecman. 1998. Silymarin as a potential hypocholesterolaemic drug. *Physiol. Res.* 47: 1-7.
- Sobolova, L., N. Skottova, R. Vecera, and K. Urbanek. 2006. Effect of silymarin and its polyphenolic fraction on cholesterol absorption in rats. *Pharmacol. Res.* 53: 104-112.

- Souissi, T., D.K. Berner, and E.L. Smallwood. 2005. First report of smut caused by *Microbotryum silybum* on ivory thistle. *Plant Dis.* 89: 1242-1242.
- Sudha, G. and G.A. Ravishankar. 2002. Involvement and interaction of various signaling compounds on the plant metabolic events during defense response, resistance to stress factors, formation of secondary metabolites and their molecular aspects. *Plant Cell Tiss. Org.* 71: 181-212.
- Svobodova, A., A. Zdarilova, J. Maliskova, H. Mikulkova, D. Walterova, and J. Vostalova. 2007. Attenuation of UVA-induced damage to human keratinocytes by silymarin. *J. Derm. Sci.* 46: 21-30.
- Taylor, J.L.S., T. Rabe, L.J. McGaw, A.K. Jager, and J. van Staden. 2001. Towards the scientific validation of traditional medicinal plants. *Plant Growth Regul.* 34: 23-37.
- Tedesco, D., S. Steidler, S. Galletti, M. Tamani, O. Sonzogni, and L. Ravarotto. 2004a. Efficacy of silymarin-phospholipid complex in reducing the toxicity of aflatoxin B-1 in broiler chicks. *Poultry Sci.* 83: 1839-1843.

- Tedesco, D., A. Tava, S. Galletti, M. Tameni, G. Varisco, A. Costa, and S. Steidler. 2004b. Effects of silymarin, a natural hepatoprotector, in periparturient dairy cows. *J. Dairy Sci.* 87: 2239-2247.
- Tyagi, A., N. Bhatia, M.S. Condon, M.C. Bosland, C. Agarwal, and R. Agarwal. 2002. Antiproliferative and apoptotic effects of Silibinin in rat prostate cancer cells. *Prostate.* 53: 211-217.
- Wagner, H. 1999. Phytomedicine research in Germany. *Environ. Health Persp.* 107: 779-781.
- Wagner, H., P. Diesel, and M. Seitz. 1974. Chemistry and analysis of silymarin from *Silybum marianum*. *Arzneim. Forsch.* 24: 466-471.
- Wallace, S., D.J. Carrier, R.R. Beitle, E.C. Clausen, and C.L. Griffis. 2003. HPLC-UV and LC-MS-MS characterization of silymarin in milk thistle seeds and corresponding products. *J. Nutraceut. Funct. Med. Foods.* 4: 37-48.
- Williamson, E.M. 2001. Synergy and other interactions in phytomedicines. *Phytomedicine.* 8: 401-409.

Wills, R.B.H., K. Bone, and M. Morgan. 2000. Herbal products: active constituents, modes of action and quality control. *Nut. Res. Rev.* 13: 47-77.

Wink, M. 2003. Evolution of secondary metabolites from an ecological and molecular phylogenetic perspective. *Phytochemistry.* 64: 3-19.

Zheljazkov, V.D., I. Zhalnov, and N.K. Nedkov. 2006. Herbicides for weed control in blessed thistle (*Silybum marianum*). *Weed Technol.* 20: 1030-1034.

Appendix A: Figures

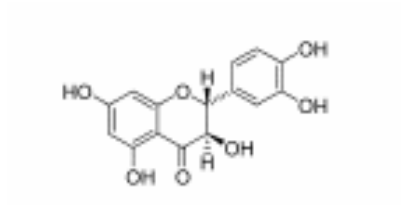

Taxifolin

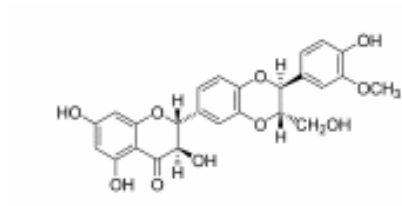

Isosilybin B

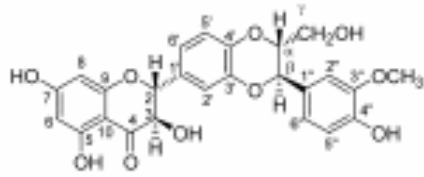

Silybin A

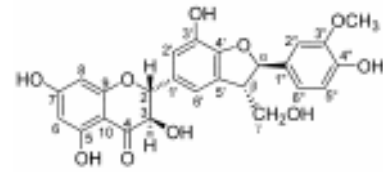

Silychristin A

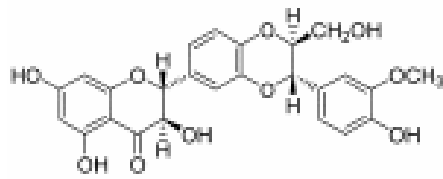

Silybin B

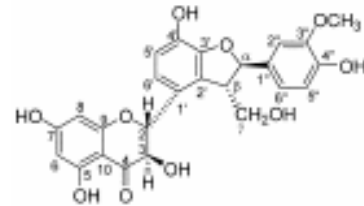

Silychristin B

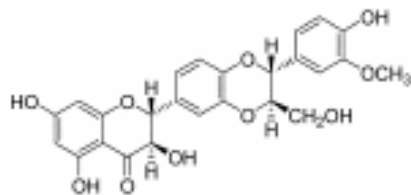

Isosilybin A

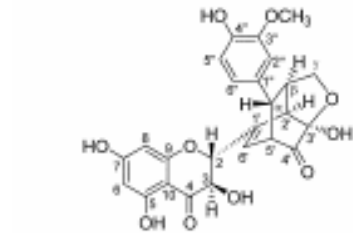

Silydianin

Figure A-1: Chemical structures of silymarin components found in milk thistle seeds.



Figure A-2: *Silybum marianum* in flower in preliminary experiment. Plants are growing in 4-inch polystyrene trays.

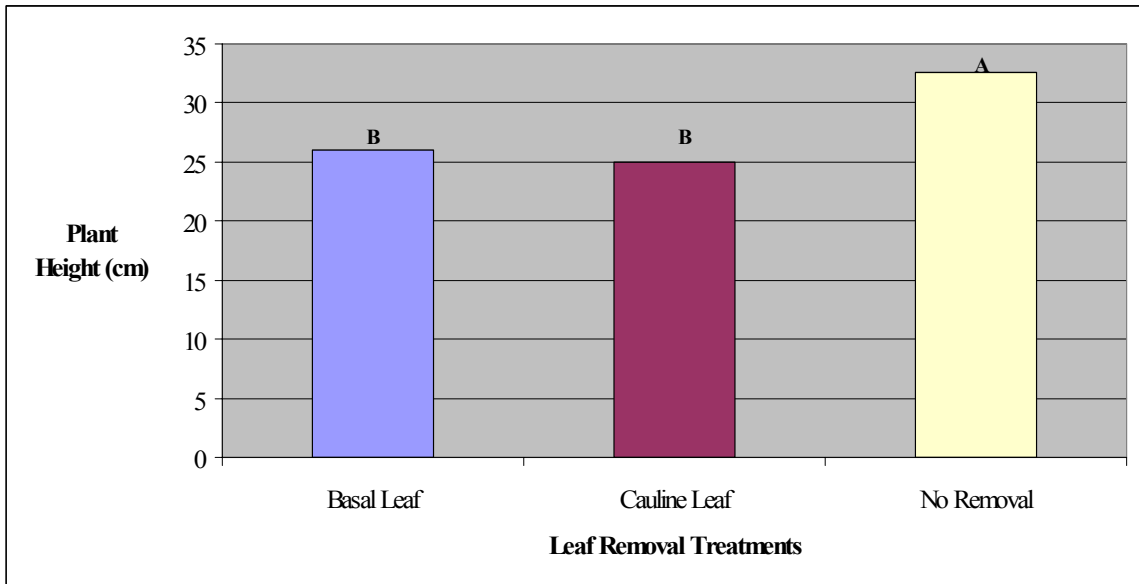

Figure A-3: Effect of single leaf removal treatments on plant height in milk thistle (*Silybum marianum*) seeds. Data analyzed with mixed model ANOVA. LSD means separation shown ($P < 0.05$).

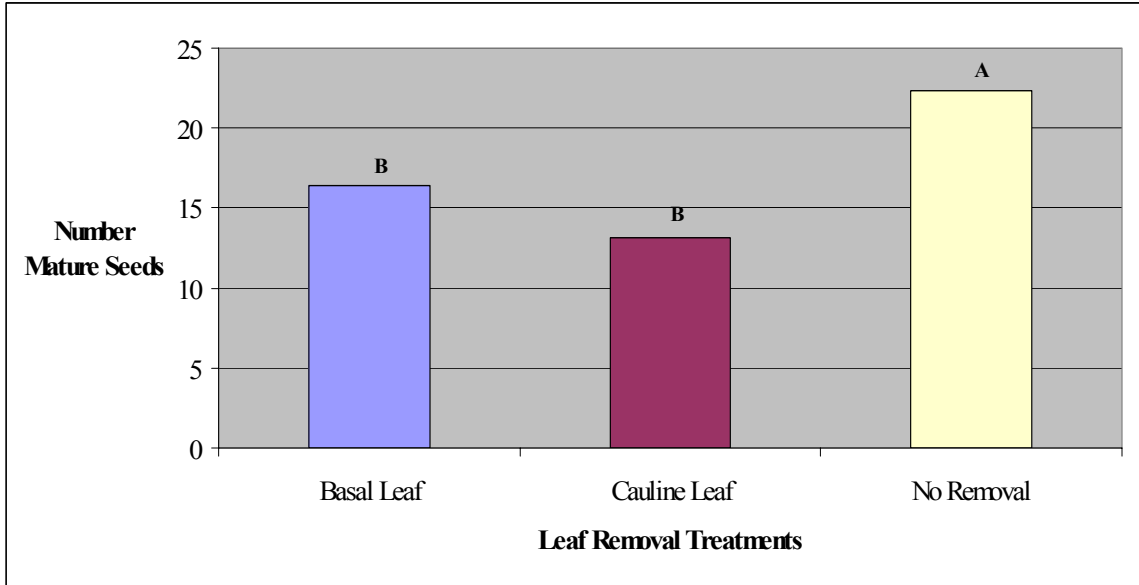

Figure A-4: Effect of single leaf removal treatments on number of mature seeds in milk thistle (*Silybum marianum*). Data analyzed with mixed model ANOVA. LSD means separation shown ($P < 0.05$).

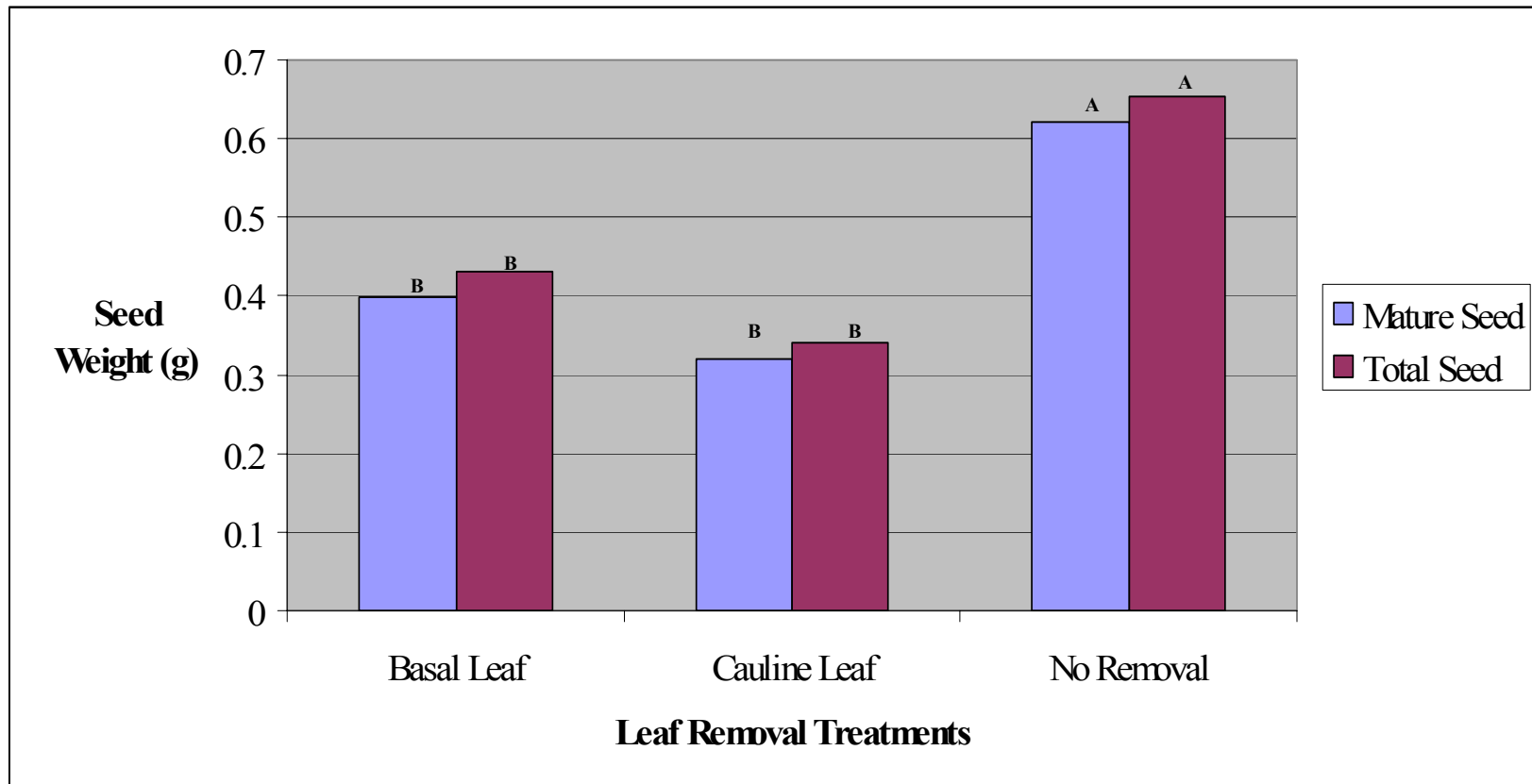

Figure A-5: Effect of single leaf removal treatments on mature and total seed weights in milk thistle (*Silybum marianum*). Data analyzed with mixed model ANOVA. LSD means separation shown ($P < 0.05$).

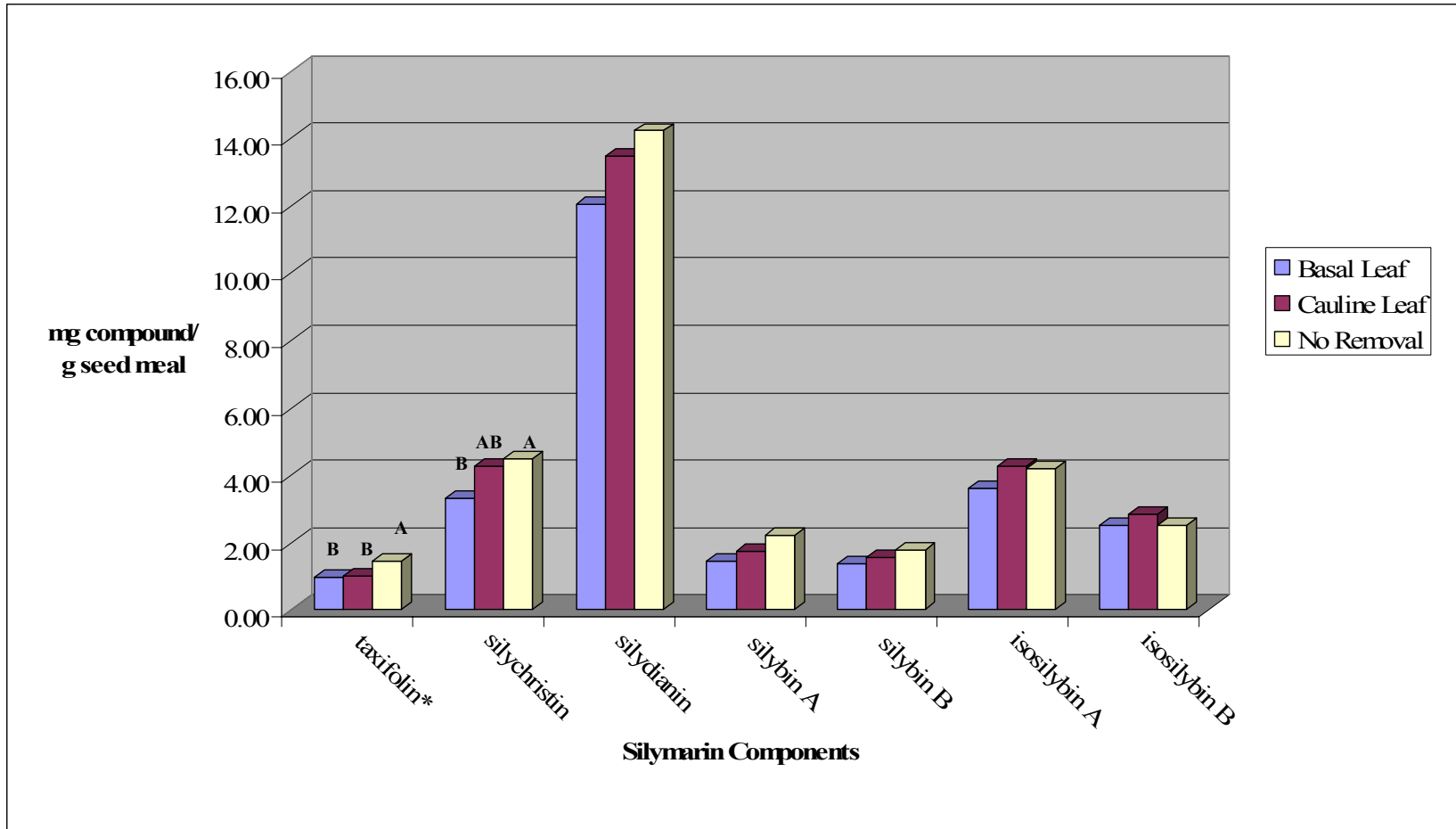

Figure A-6: Effect of single leaf removal treatments on concentrations of silymarin components in milk thistle (*Silybum marianum*) seeds. Data analyzed with mixed model ANOVA. LSD means separation shown ($P < 0.05$). * denotes significantly affected component.

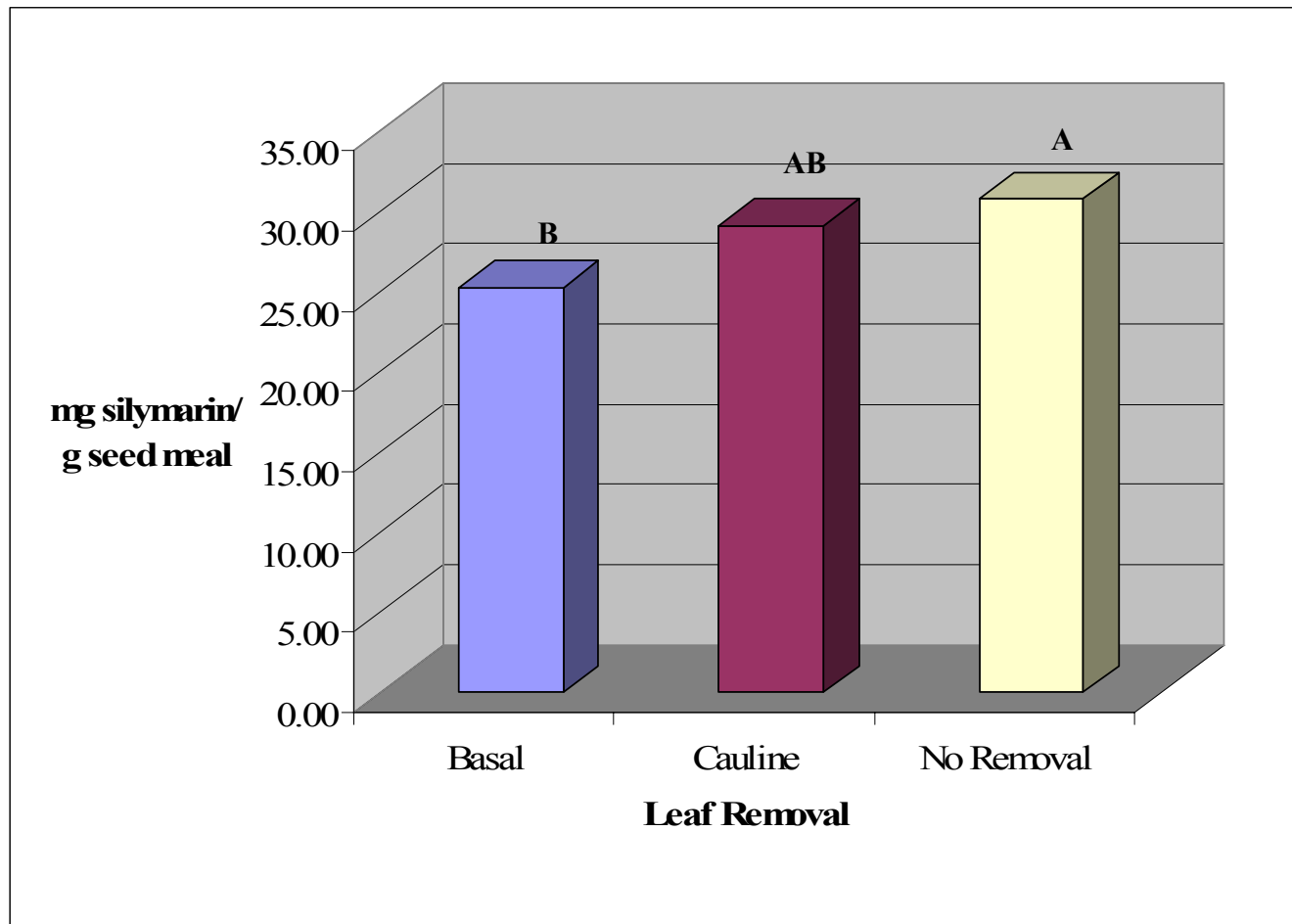

Figure A-7: Effect of single leaf removal treatments on total levels of silymarin in milk thistle (*Silybum marianum*) seeds. Data analyzed with mixed model ANOVA. LSD means separation shown ($\alpha=0.05$).

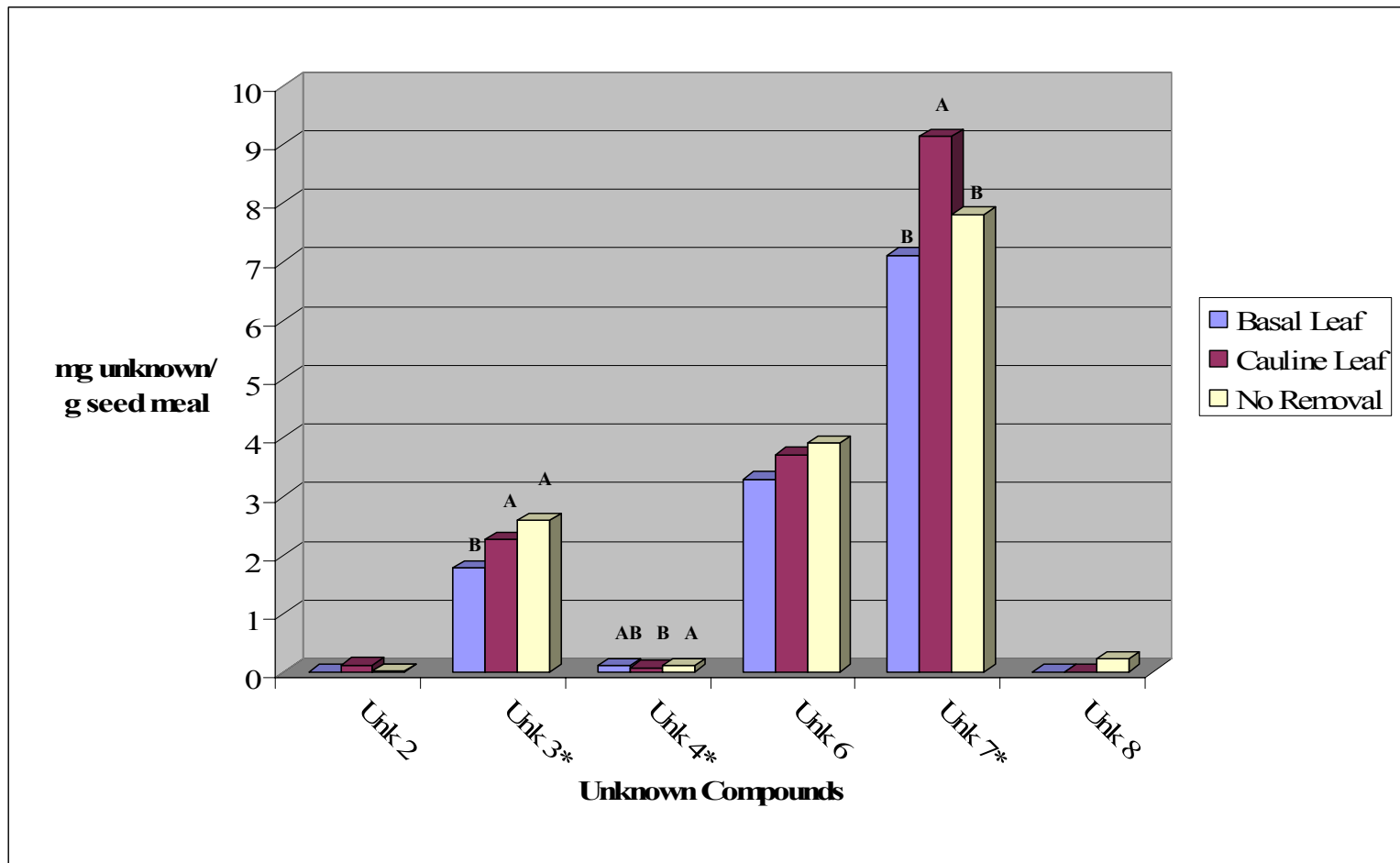

Figure A-8: Effect of single leaf removal treatments on concentrations of unknown compounds in milk thistle (*Silybum marianum*) seeds. Data analyzed with mixed model ANOVA. LSD means separation are shown ($\alpha=0.05$). * denotes significantly affected unknown compounds.

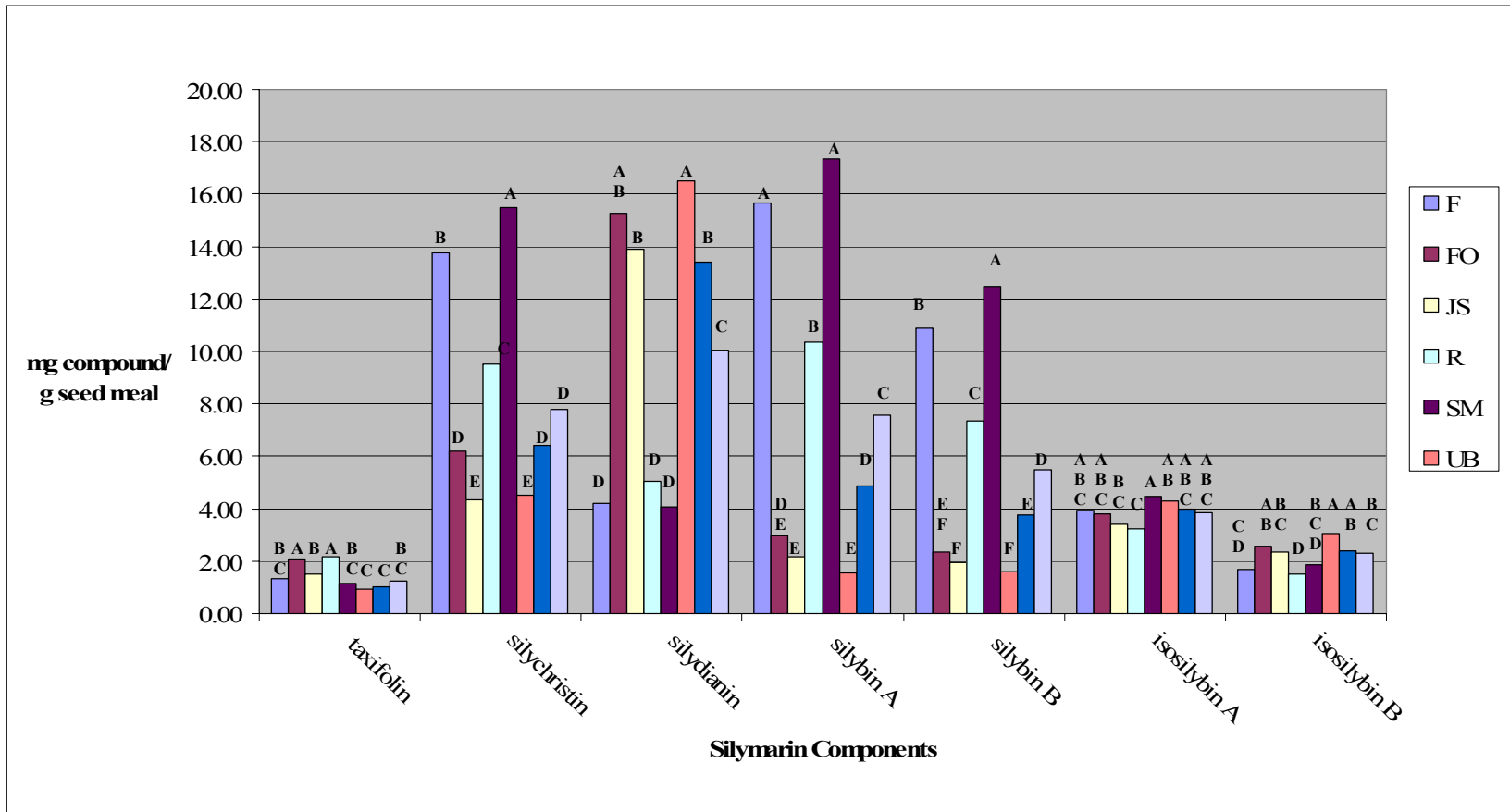

Figure A-9: Concentration of silymarin components in various sources of milk thistle (*Silybum marianum*) seeds. Seed sources were as follows: F=Frontier; FO=Frontier (Organic); JS=Johnny’s Select; R=Richters Herbs; SM=Stony Mountain Botanicals; UB=University of Belgrade; WWC=Wild Weeds (Croatia); WWO=Wild Weeds (Oregon). Seed sources were significantly different based on mixed model ANOVA. Tukey means separation is shown at $P < 0.05$.

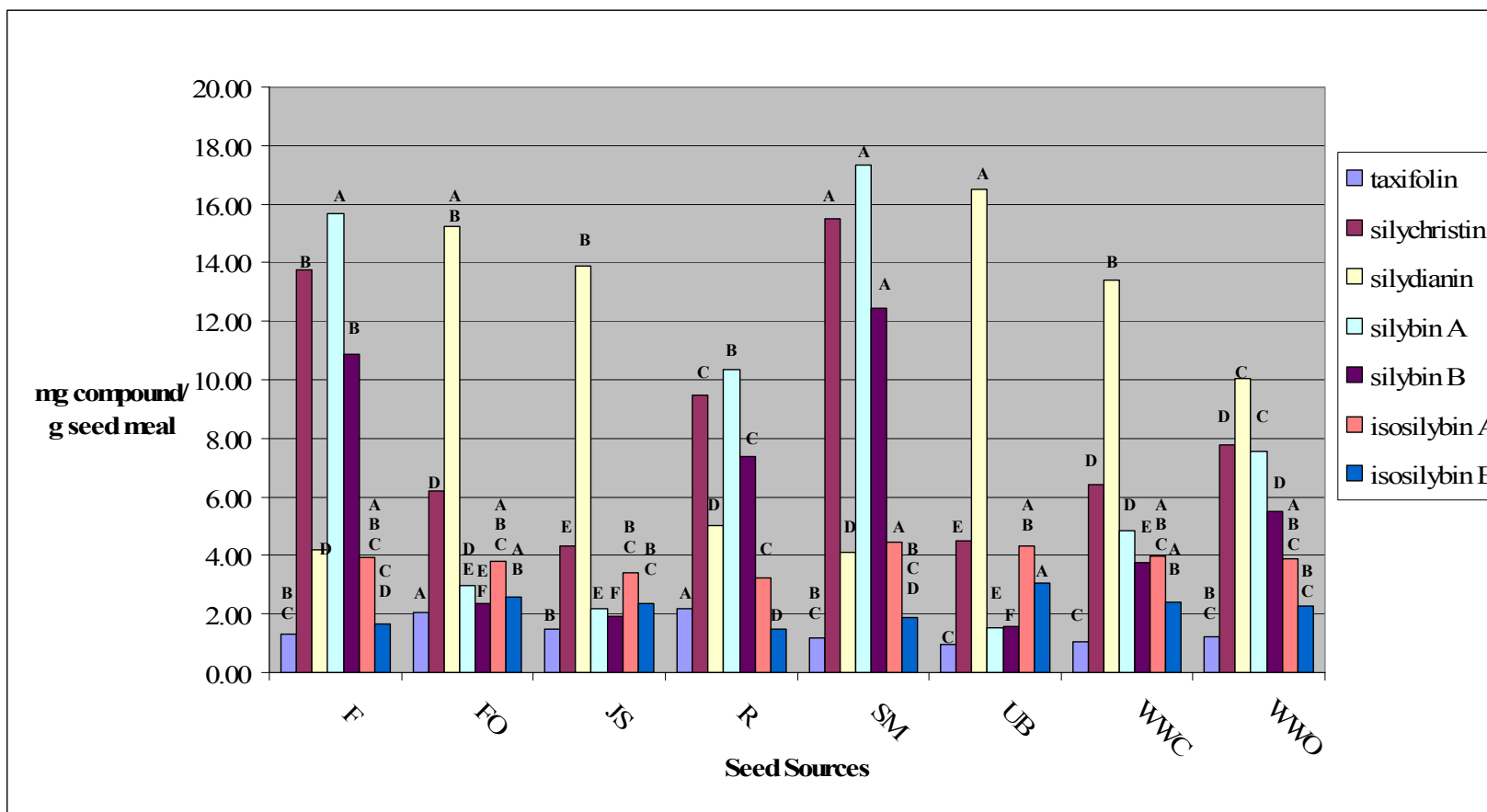

Figure A-10: Flavonolignan profile in various sources of milk thistle (*Silybum marianum*) seeds. Seed sources were as follows: F=Frontier; FO=Frontier (Organic); JS=Johnny’s Select; R=Richters Herbs; SM=Stony Mountain Botanicals; UB=University of Belgrade; WWC=Wild Weeds (Croatia); WWO=Wild Weeds (Oregon). All components were significantly different based on mixed model ANOVA (P<0.05).

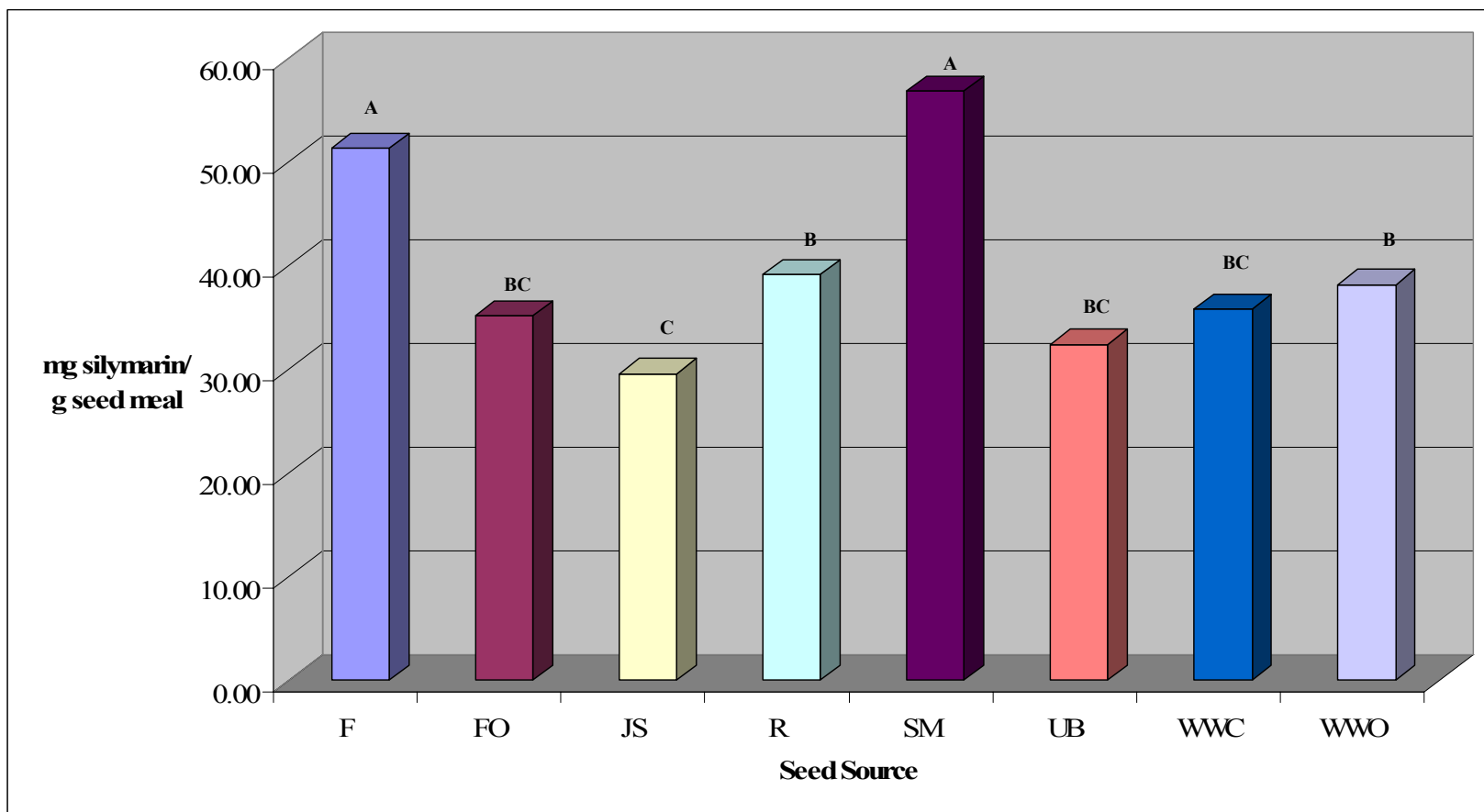

Figure A-11: Total concentrations of silymarin in various sources of milk thistle (*Silybum marianum*) seeds. Seed sources were as follows: F=Frontier; FO=Frontier (Organic); JS=Johnny's Select; R=Richters Herbs; SM=Stony Mountain Botanicals; UB=University of Belgrade; WWC=Wild Weeds (Croatia); WWO=Wild Weeds (Oregon). Total concentrations were significantly different based on mixed model ANOVA. Tukey means separation is shown at $P < 0.05$.

1	2	16	4
24	20	8	12

Block 1

16	24	20	1
4	12	8	2

Block 2

Figure A-12: Experimental design for population density effects on growing plants. Each number represents the number of plants contained in each growth bag.



Figure A-13: One block of all population density treatments of milk thistle (*Silybum marianum*) between true leaf stages 10-20.



Figure A-14: Growth data collection and seed harvest of milk thistle (*Silybum marianum*) in population density treatments in walk-in growth chamber.

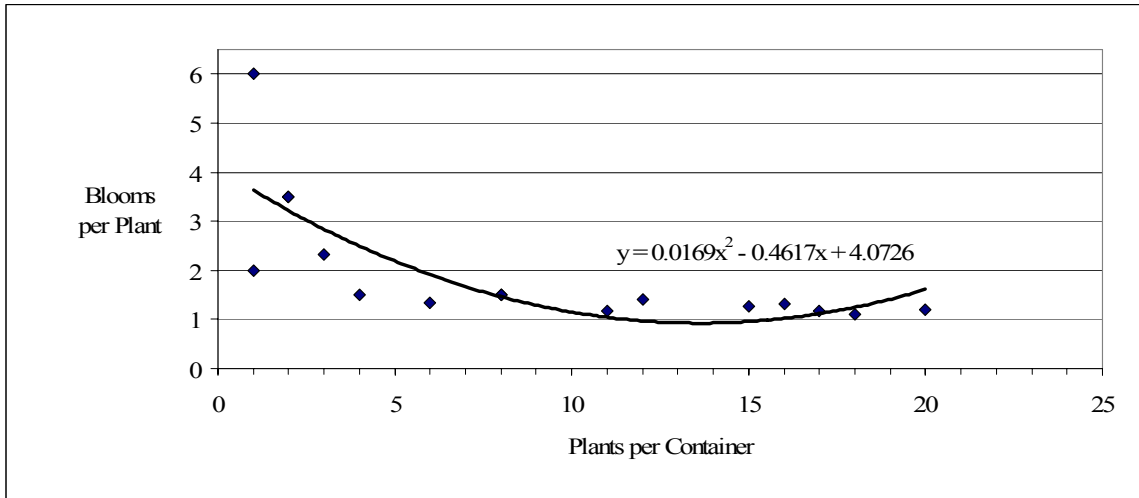

Figure A-15: Number of blooms per plant in milk thistle (*Silybum marianum*) grown at different numbers of plants per container ($R^2=0.59$). Data analyzed using quadratic regression ($P<0.05$).

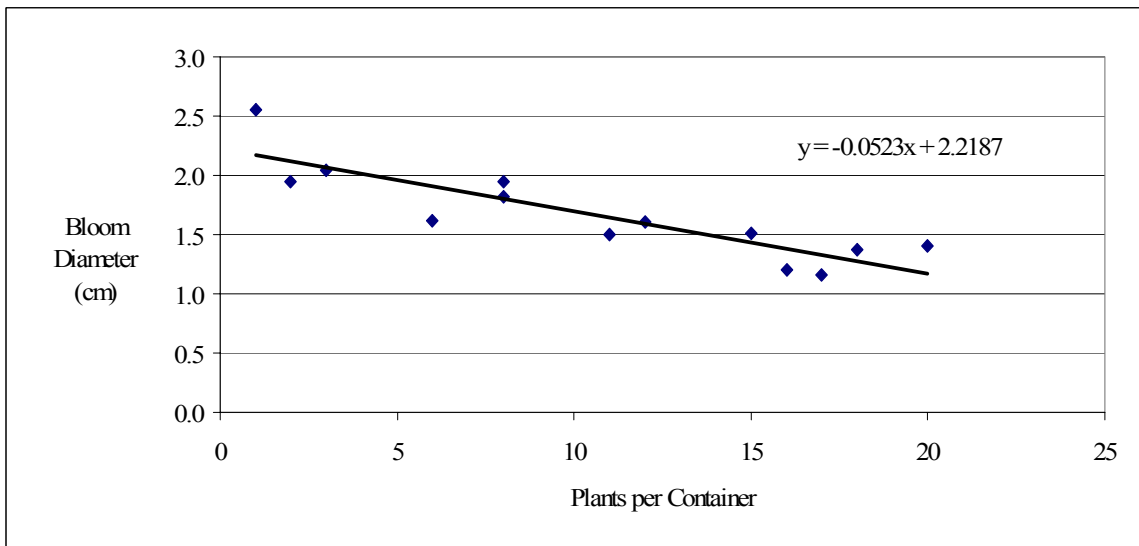

Figure A-16: Bloom diameter in milk thistle (*Silybum marianum*) grown at different numbers of plants per container ($R^2=0.72$). Data analyzed using simple linear regression ($P<0.05$).

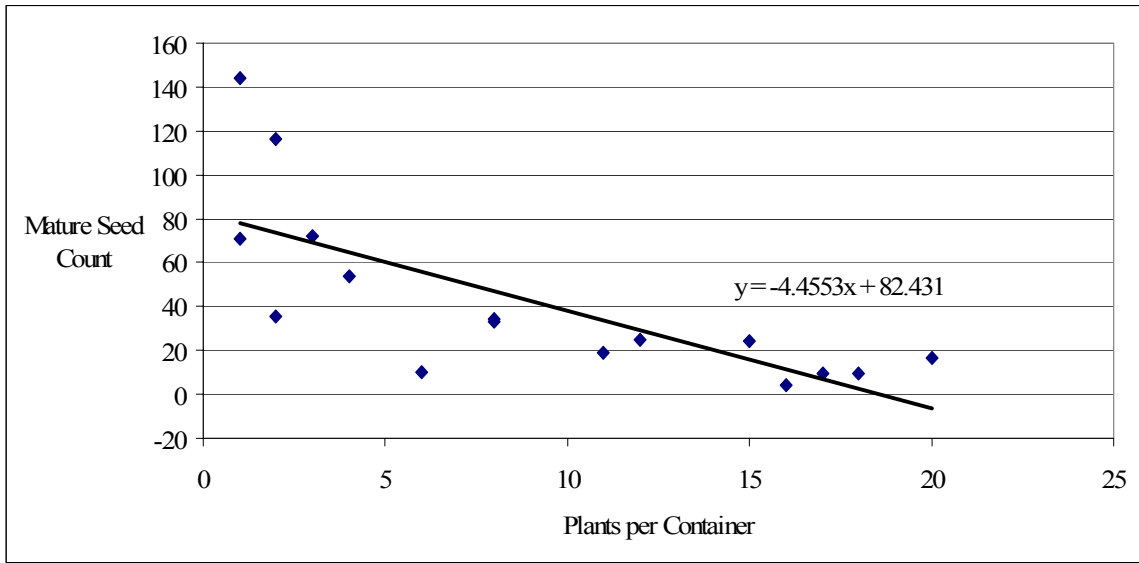

Figure A-17: Number of mature seeds in milk thistle (*Silybum marianum*) grown at different numbers of plants per container ($R^2=0.54$). Data analyzed using simple linear regression ($P<0.05$).

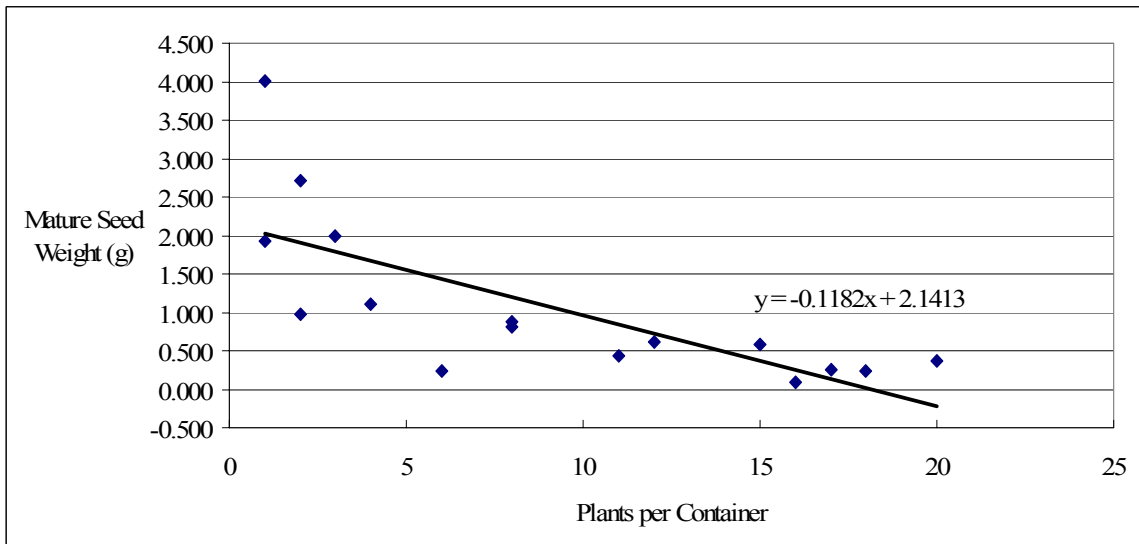

Figure A-18: Weight of mature seeds in milk thistle (*Silybum marianum*) grown at different numbers of plants per container ($R^2=0.53$). Data analyzed using simple linear regression ($P<0.05$).

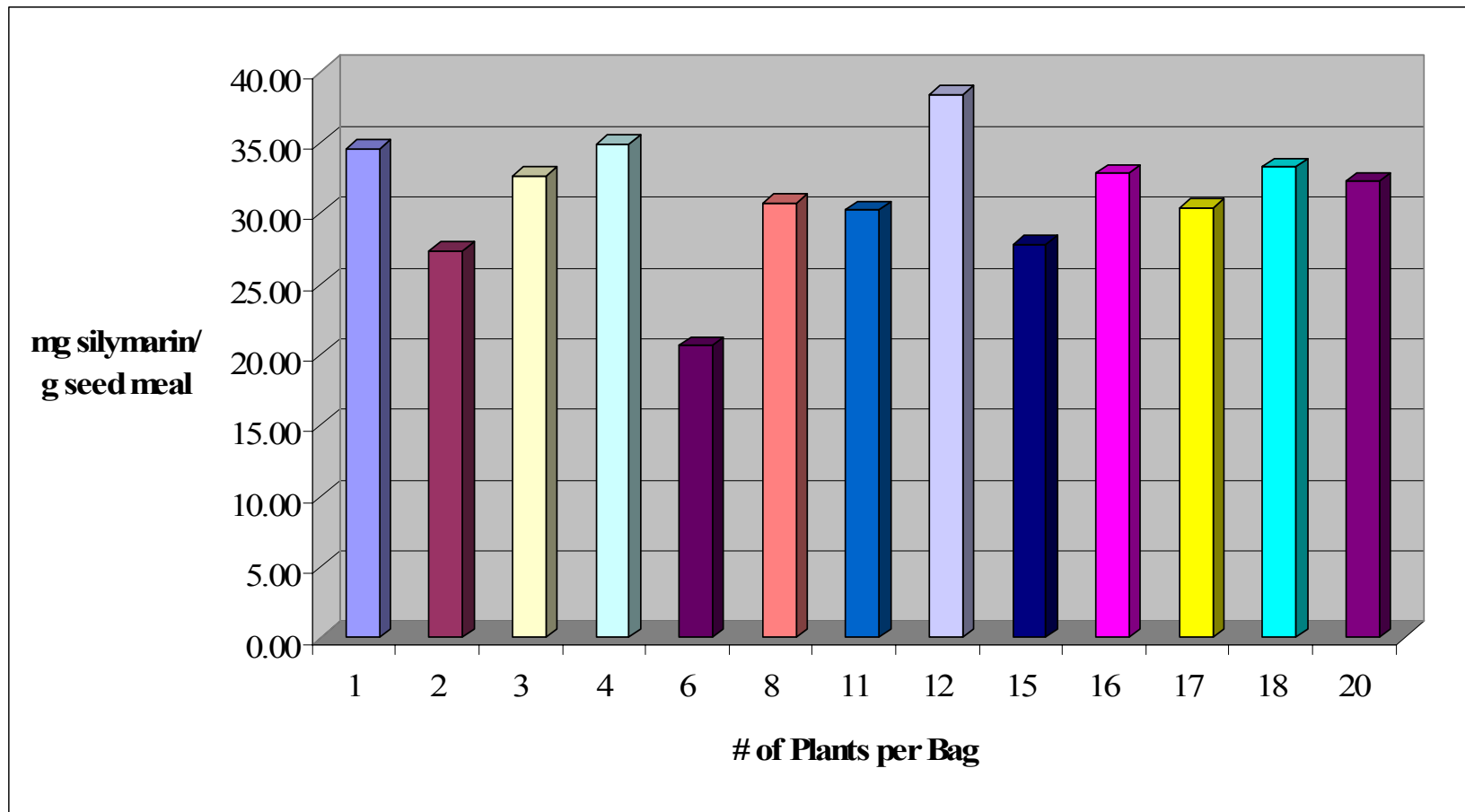

Figure A-19: Silymarin concentration in milk thistle (*Silybum marianum*) seeds from varying population densities. Concentrations were not significant using simple linear regression at $P < 0.05$.

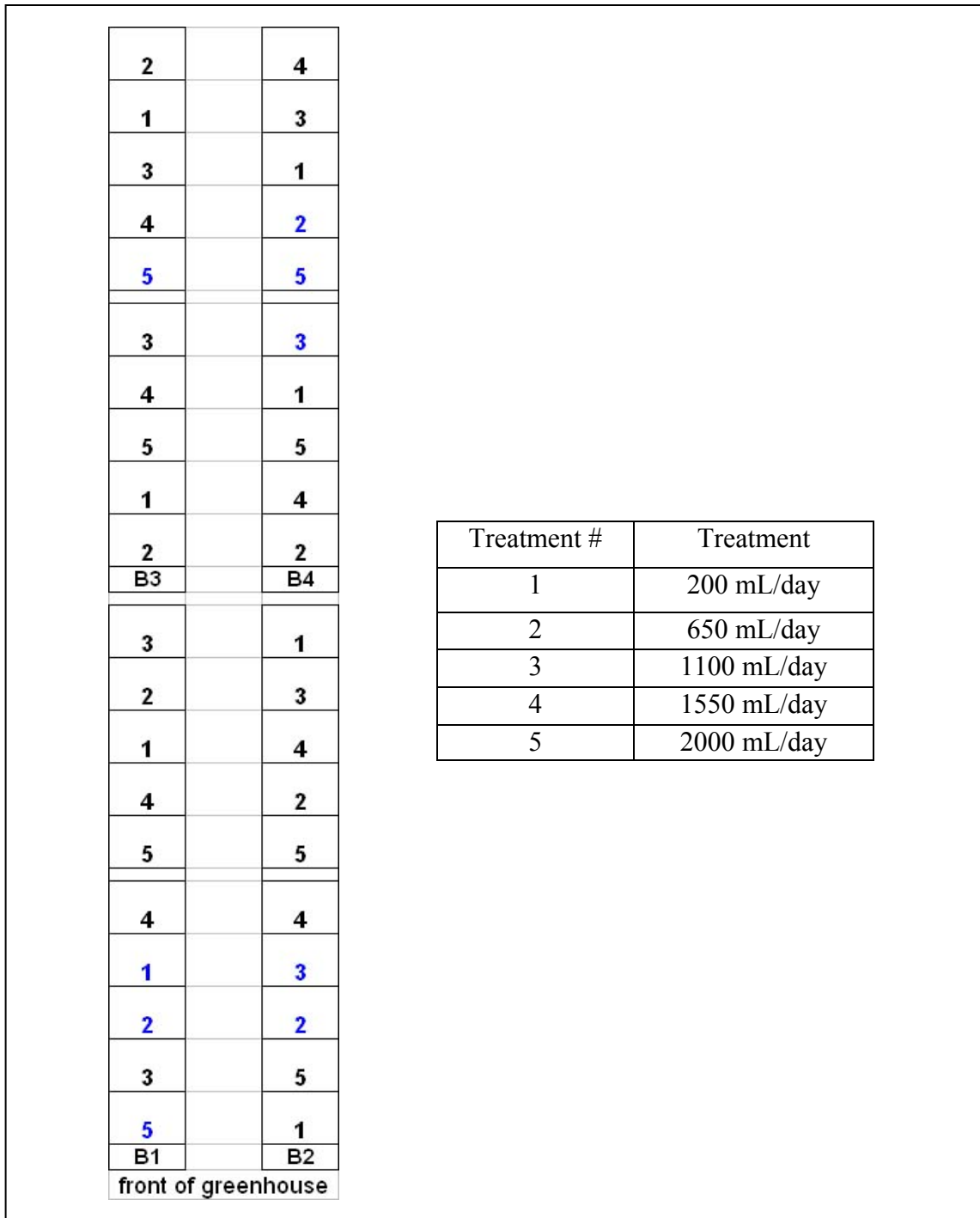

Figure A-20: Experimental design for water stress experiment. Each number represents a treatment level. 100 mL of each treatment/day is fertigate.



Figure A-21: Hydroponic apparatus in greenhouse used to determine the effects of water stress on milk thistle (*Silybum marianum*) plants.

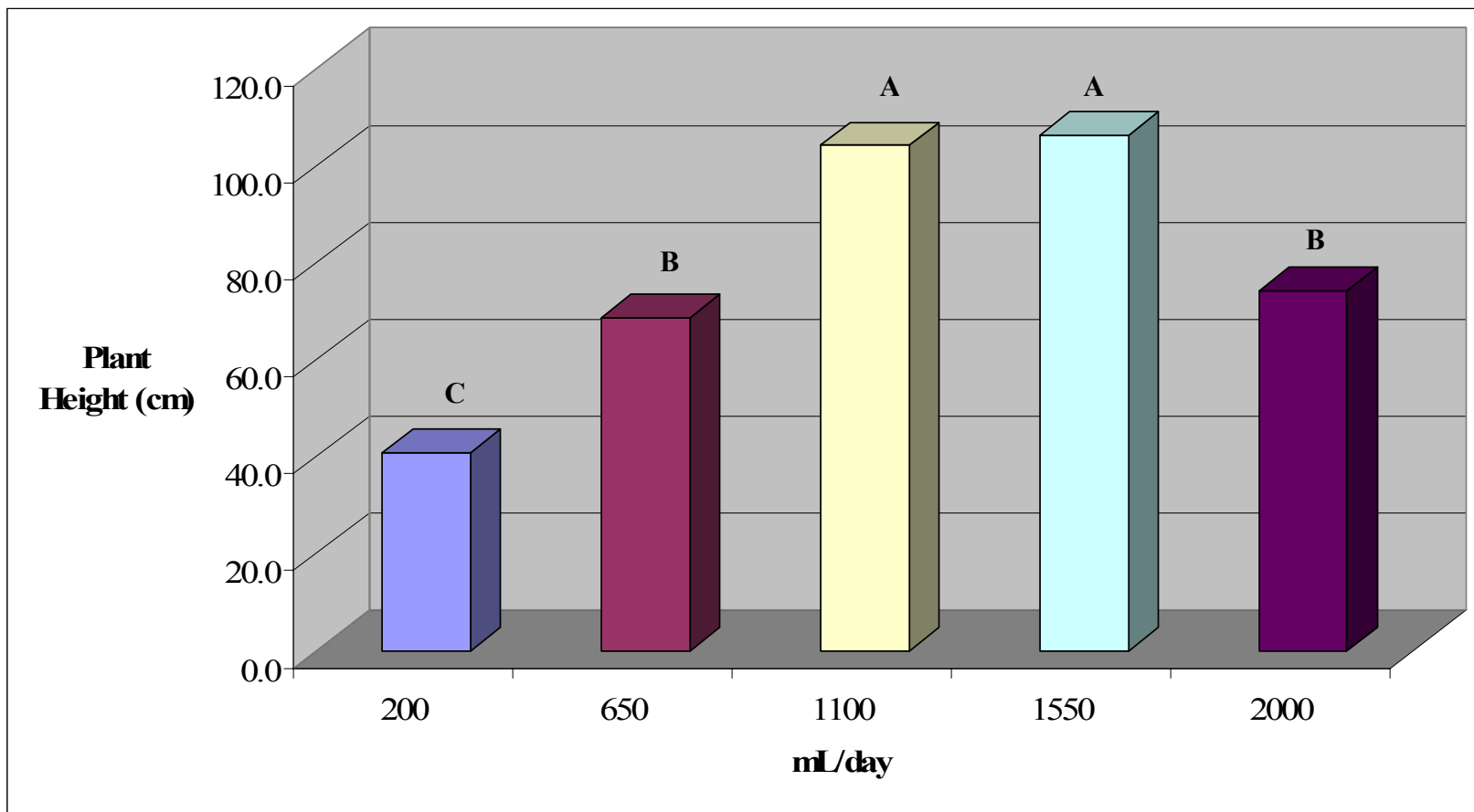

Figure A-22: Average stem height per plant in milk thistle (*Silybum marianum*) grown under varying daily water rates. Data analyzed using RBD with replication model. LSD means separation is shown (significance at $P < 0.05$).

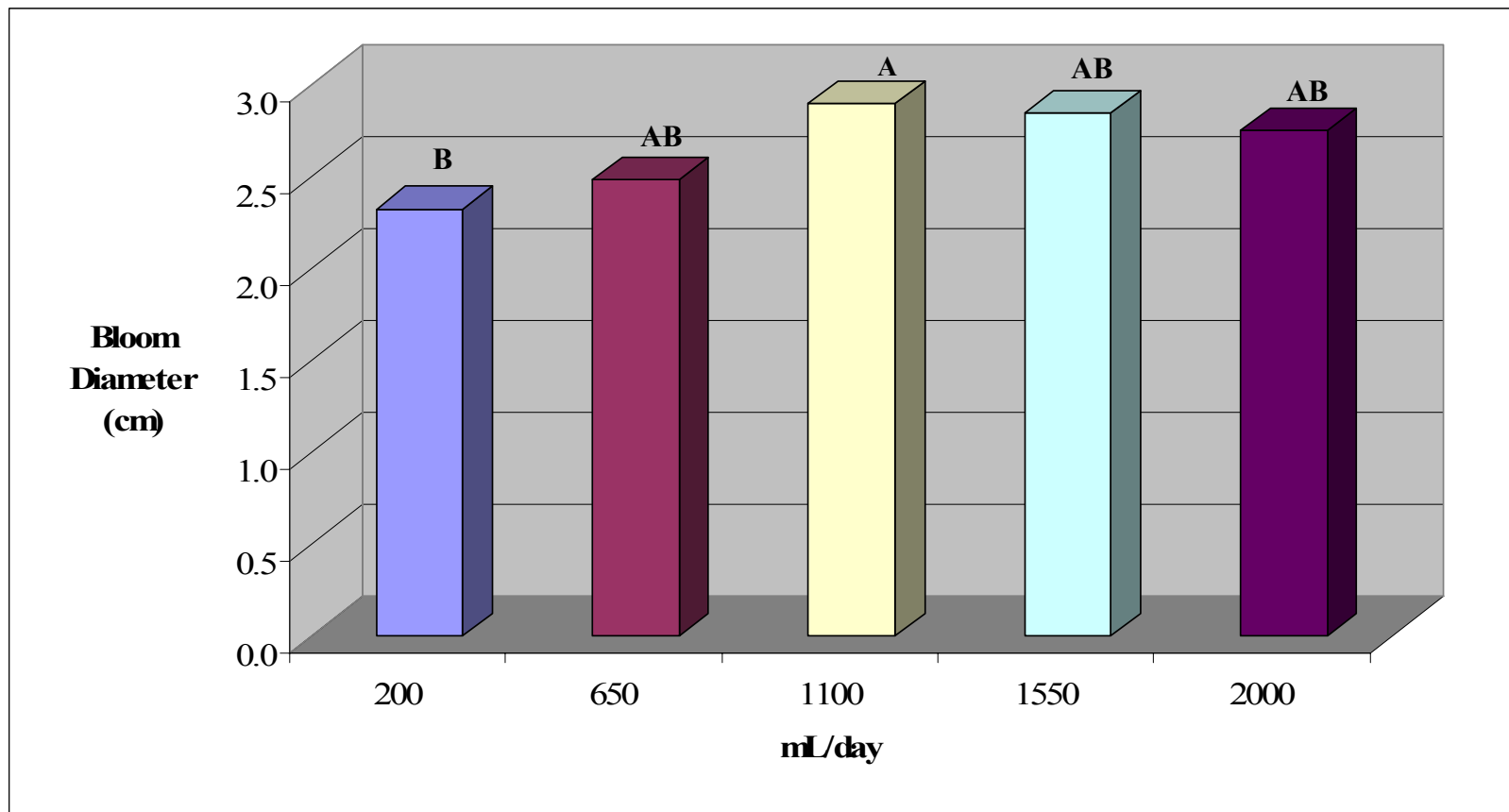

Figure A-23: Average bloom diameter per plant in milk thistle (*Silybum marianum*) grown under varying daily water rates. Data analyzed using RBD with replication model. LSD means separation is shown (significance at $P < 0.05$).

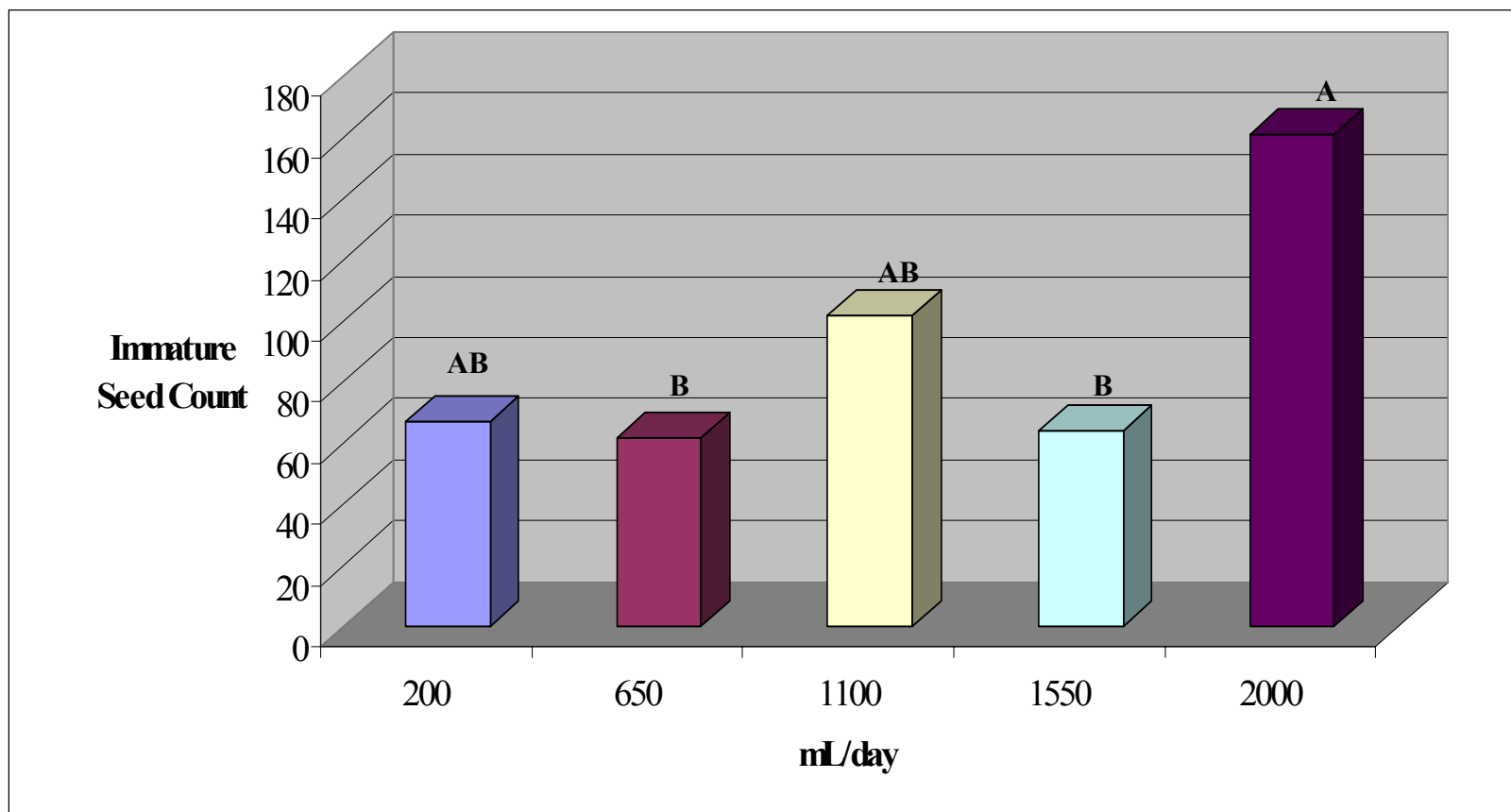

Figure A-24: Average count of immature seeds per plant in milk thistle (*Silybum marianum*) grown under varying daily water rates. Data analyzed using RBD with replication model. LSD means separation is shown (significance at $P < 0.05$).

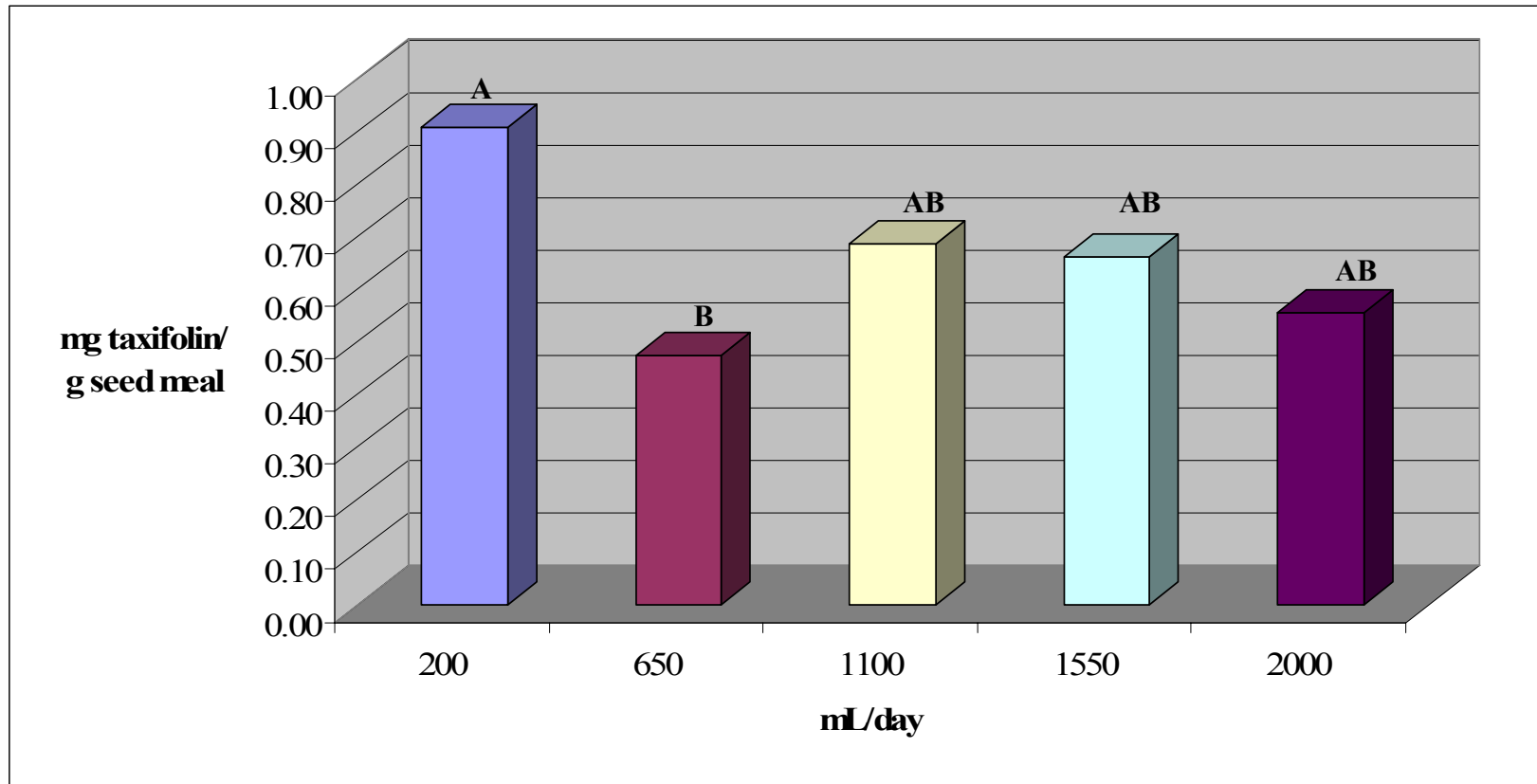

Figure A-25: Taxifolin concentration in primary blooms of milk thistle (*Silybum marianum*) grown under varying daily water rates. Concentration is in mg of taxifolin per g of seed meal. Data analyzed using RBD with replication and sampling model. LSD means separation is shown (significance at $P < 0.05$).

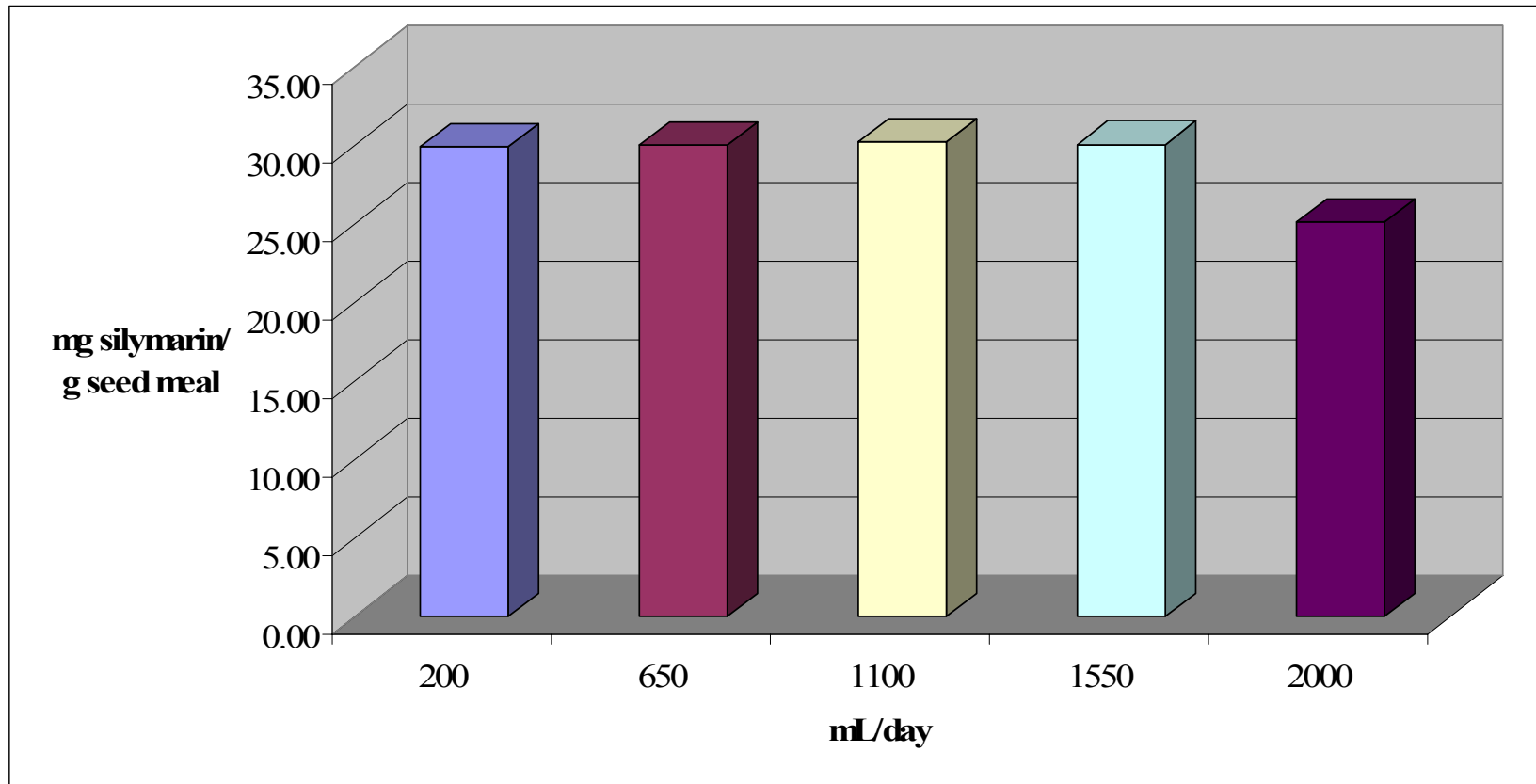

Figure A-26: Silymarin concentration in primary blooms of milk thistle (*Silybum marianum*) grown under varying daily water rates. Concentration is in mg of taxifolin per g of seed meal. Data analyzed using RBD with replication and sampling model. Silymarin concentrations were not significantly different at $P < 0.05$.

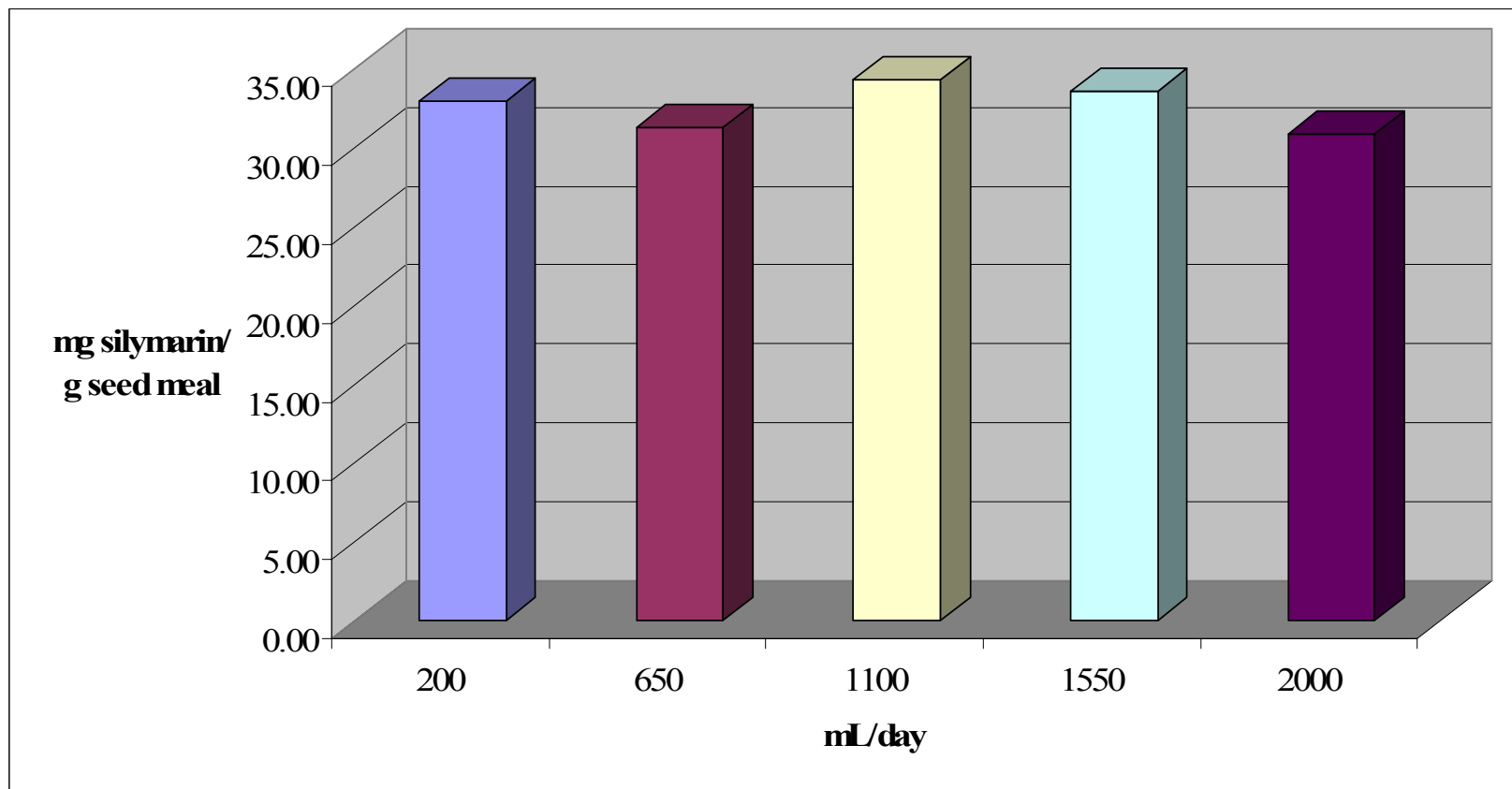

Figure A-27: Silymarin concentration in secondary blooms of milk thistle (*Silybum marianum*) grown under varying daily water rates. Concentration is in mg of taxifolin per g of seed meal. Data analyzed using RBD with replication and sampling model. Silymarin concentrations were not significantly different at $P < 0.05$.



Figure A-28: Aphids and whiteflies on a milk thistle (*Silybum marianum*) leaf in hydroponic greenhouse production.

Appendix B: Tables

Table B-1: Solvent gradient for HPLC analysis of milk thistle (*Silybum marianum*) seeds.

Time (min)	Solvent A (CH ₃ OH:H ₂ O)	Solvent B (CH ₃ OH:H ₂ O)
0	85	15
5	85	15
20	45	55
35	45	55
38	0	100
43	0	100
44	85	15

Solvent A is 20% CH₃OH and 80% H₂O

Solvent B is 80% CH₃OH and 20% H₂O

Time is in minutes

Table B-2: Growth and yield parameters of milk thistle (*Silybum marianum*) in different single leaf removal treatments.

Removal	Stem Height (cm)*	# Mature Seeds*	# Immature Seeds	Total # Seeds*	Mature Seed Weight (g)*	Immature Seed Weight (g)	Total Seed Weight (g)*	Days to Maturity
Basal Leaf	26.0 ± 3.1 B	16 ± 8 B	8 ± 7	24 ± 7 AB	0.399 ± 0.151 B	0.033 ± 0.043	0.432 ± 0.132 B	154 ± 1
Cauline Leaf	25.0 ± 4.5 B	13 ± 6 B	6 ± 3	19 ± 7 B	0.319 ± 0.175 B	0.021 ± 0.027	0.340 ± 0.167 B	149 ± 10
No Removal	32.6 ± 4.2 A	22 ± 8 A	11 ± 16	33 ± 14 A	0.621 ± 0.188 A	0.034 ± 0.061	0.654 ± 0.172 A	147 ± 11

* denotes statistical significance at P<0.05 by mixed model ANOVA.

Means separation by LSD (P<0.05).

Table B-3: Concentrations of silymarin and silymarin components in milk thistle (*Silybum marianum*) seeds in different single leaf removal treatments.

Removal	Taxifolin*	Silychristin	Silydianin	Silybin A	Silybin B	Isosilybin A	Isosilybin B	Total
Basal Leaf	0.95 ± 0.26	3.31 ± 0.33	12.02 ± 2.80	1.43 ± 0.16	1.37 ± 0.15	3.61 ± 0.38	2.50 ± 0.29	25.20 ± 4.06
Cauline Leaf	0.98 ± 0.30	4.27 ± 0.69	13.46 ± 1.81	1.72 ± 0.23	1.54 ± 0.23	4.26 ± 0.64	2.83 ± 0.49	29.06 ± 3.97
No Removal	1.43 ± 0.21	4.48 ± 0.75	14.22 ± 1.87	2.19 ± 1.11	1.75 ± 0.71	4.18 ± 0.39	2.49 ± 0.63	30.73 ± 3.02

concentrations in mg of compound/g of seed meal.

* denotes statistical significance at P<0.05 by mixed model ANOVA.

Table B-4: Concentrations of unknown compounds in milk thistle (*Silybum marianum*) seeds in different single leaf removal treatments.

Removal	Unk 2	Unk 3*	Unk 4*	Unk 6	Unk 7*	Unk 8
Basal Leaf	0.00 ± 0.00	1.77 ± 0.42	0.10 ± 0.03	3.28 ± 0.45	7.10 ± 0.83	0.00 ± 0.00
Cauline Leaf	0.11 ± 0.21	2.26 ± 0.46	0.07 ± 0.03	3.70 ± 0.61	9.13 ± 1.53	0.00 ± 0.00
No Removal	0.02 ± 0.08	2.58 ± 0.44	0.11 ± 0.03	3.90 ± 0.46	7.79 ± 1.15	0.23 ± 0.62

concentrations in mg of compound per g of seed meal.

* denotes statistical significance at P<0.05 by mixed model ANOVA.

Table B-5: Concentrations of silymarin components in various sources of milk thistle (*Silybum marianum*) seeds.

Sources	Taxifolin	Silychristin	Silydianin	Silybin A	Silybin B	Isosilybin A	Isosilybin B	Total
F	1.32 ± 0.02	13.75 ± 0.67	4.19 ± 0.11	15.68 ± 1.32	10.89 ± 0.88	3.92 ± 0.33	1.66 ± 0.05	51.41 ± 3.34
FO	2.07 ± 0.27	6.20 ± 0.20	15.25 ± 0.15	2.97 ± 0.19	2.36 ± 0.09	3.79 ± 0.04	2.56 ± 0.09	35.19 ± 0.21
JS	1.50 ± 0.01	4.34 ± 0.54	13.91 ± 0.48	2.19 ± 0.20	1.93 ± 0.12	3.40 ± 0.24	2.34 ± 0.06	29.60 ± 1.66
R	2.18 ± 0.12	9.50 ± 0.64	5.03 ± 0.59	10.33 ± 0.69	7.36 ± 0.39	3.25 ± 0.29	1.50 ± 0.06	39.15 ± 2.79
SM	1.17 ± 0.11	15.51 ± 0.19	4.09 ± 0.49	17.33 ± 0.31	12.47 ± 0.22	4.47 ± 0.33	1.87 ± 0.37	56.90 ± 0.99
UB	0.95 ± 0.01	4.50 ± 0.25	16.50 ± 0.59	1.54 ± 0.14	1.58 ± 0.11	4.31 ± 0.33	3.07 ± 0.25	32.45 ± 1.69
WWC	1.03 ± 0.03	6.44 ± 0.11	13.41 ± 0.45	4.87 ± 0.33	3.75 ± 0.17	3.97 ± 0.03	2.39 ± 0.01	35.86 ± 0.15
WWO	1.24 ± 0.08	7.77 ± 0.10	10.03 ± 1.25	7.55 ± 0.00	5.48 ± 0.02	3.87 ± 0.22	2.29 ± 0.18	38.23 ± 1.82

Seed sources were as follows: F=Frontier; FO=Frontier (organic); JS=(Johnny's Select); R=Richters Herbs; SM=Stony Mountain Botanicals; UB=University of Belgrade; WWC=Wild Weeds (Croatia); WWO=Wild Weeds (Oregon).

Concentrations are in mg compound per g seed meal. All silymarin compounds were significantly affected by seed source by mixed model ANOVA at P<0.05.

Table B-6: Concentrations of unknown compounds in various sources of milk thistle (*Silybum marianum*) seeds.

Sources	Unk 2	Unk 3	Unk 4	Unk6	Unk 7	Unk 8
F	0.24 ± 0.04	2.54 ± 0.42	0.17 ± 0.01	5.79 ± 0.66	3.91 ± 0.12	5.91 ± 0.12
FO	0.14 ± 0.02	1.68 ± 0.22	0.17 ± 0.01	5.84 ± 0.04	7.55 ± 0.47	0.00 ± 0.00
JS	0.09 ± 0.13	1.81 ± 0.81	0.10 ± 0.02	3.93 ± 0.25	6.42 ± 0.79	0.00 ± 0.00
R	0.00 ± 0.00	1.66 ± 0.26	0.39 ± 0.04	4.75 ± 0.14	3.89 ± 0.47	3.28 ± 0.39
SM	0.21 ± 0.01	2.66 ± 0.00	0.15 ± 0.02	3.95 ± 0.30	4.08 ± 0.14	6.56 ± 1.50
UB	0.22 ± 0.05	2.47 ± 0.37	0.10 ± 0.04	3.78 ± 0.73	7.90 ± 0.63	0.00 ± 0.00
WWC	0.25 ± 0.06	2.10 ± 0.48	0.13 ± 0.03	4.19 ± 0.03	6.51 ± 0.20	2.20 ± 0.09
WVO	0.27 ± 0.00	1.74 ± 0.08	0.15 ± 0.03	4.13 ± 0.41	5.48 ± 0.44	2.75 ± 0.11

Seed sources were as follows: F=Frontier; FO=Frontier (organic); JS=(Johnny's Select); R=Richters Herbs; SM=Stony Mountain Botanicals; UB=University of Belgrade; WWC=Wild Weeds (Croatia); WVO=Wild Weeds (Oregon).

Concentrations are in mg compound per g seed meal. All unknown compounds were significantly affected by seed source by mixed model ANOVA at P<0.05.

Table B-7: Growth and yield parameters of milk thistle (*Silybum marianum*) at different populations of plants per container.

Plants per Container	Blooms per Plant*	Bloom Diameter (cm)*	# Mature Seeds*	# Immature Seeds	Total # Seeds*	Mature Seed Weight (g)*	Immature Seed Weight (g)	Total Seed Weight (g)*
1	2	2.6	71	159	230	1.920	0.158	2.079
1	6	n/a	144	149	293	4.015	0.207	4.222
2	4	1.9	36	170	206	0.978	0.344	1.322
2	4	n/a	117	43	159	2.717	0.062	2.779
3	2	2.0	72	40	112	1.998	0.104	2.102
4	2	n/a	54	25	79	1.107	0.027	1.134
6	1	1.6	10	40	50	0.234	0.062	0.296
8	2	1.8	33	32	65	0.820	0.048	0.867
8	2	2.0	34	40	74	0.872	0.047	0.919
11	1	1.5	19	21	40	0.441	0.026	0.467
12	1	1.6	25	34	59	0.619	0.065	0.684
15	1	1.5	24	22	46	0.576	0.023	0.599
16	1	1.2	4	23	27	0.095	0.029	0.124
17	1	1.2	9	15	25	0.246	0.020	0.266
18	1	1.4	10	22	32	0.231	0.042	0.272
20	1	1.4	17	24	41	0.376	0.098	0.474

* denotes statistical significance at $P < 0.05$ by simple linear regression.

Table B-8: Concentration of silymarin and individual flavonolignans in milk thistle (*Silybum marianum*) seeds at different populations of plants per container.

Plants per Container	Taxifolin	Silychristin	Silydianin	Silybin A	Silybin B	Isosilybin A	Isosilybin B	Total Silymarin
1	2.26	9.68	0.71	11.48	7.49	2.26	0.68	34.55
2	2.07	4.59	8.74	4.68	3.22	2.63	1.42	27.35
3	2.60	7.54	4.58	8.58	5.75	2.47	1.13	32.64
4	2.80	9.32	1.29	10.74	7.59	2.37	0.76	34.88
6	1.73	3.66	5.62	4.35	2.56	1.88	0.84	20.63
8	2.97	6.78	3.44	8.80	5.54	2.22	0.97	30.73
11	2.80	6.41	1.45	9.86	6.75	2.21	0.73	30.21
12	3.89	9.49	2.95	11.55	7.03	2.55	0.90	38.35
15	2.01	5.82	5.09	6.97	4.54	2.26	1.05	27.74
16	2.47	6.58	6.82	7.51	5.35	2.76	1.32	32.81
17	2.63	6.21	5.29	7.56	5.06	2.47	1.11	30.34
18	3.12	6.95	4.85	8.62	5.90	2.65	1.16	33.24
20	18.63	7.87	3.79	9.40	6.19	2.56	1.14	32.23

Concentration in mg compound per gram of seed meal. No flavonolignan concentrations were significant using simple linear regression at $P < 0.05$.

Table B-9: Concentration of unknown compounds in milk thistle (*Silybum marianum*) seeds at different populations of plants per container.

Plants per Container	Unk 1	Unk 2	Unk 3	Unk 4	Unk 5	Unk6	Unk 7	Unk 8
1	0.02	0.26	0.99	0.07	0.04	2.03	1.30	8.87
2	0.03	0.29	1.09	0.06	0.19	3.36	2.48	1.20
3	0.05	0.33	0.99	0.06	0.28	3.13	2.10	2.22
4	0.03	0.48	1.23	0.06	0.08	2.46	1.22	2.36
6	0.04	0.25	0.80	0.06	0.01	2.67	1.44	0.87
8	0.04	0.42	1.08	0.06	0.07	2.70	1.76	1.51
11	0.04	0.38	0.91	0.07	0.00	1.95	1.28	2.77
12	0.04	0.40	1.17	0.06	0.15	3.07	1.77	2.08
15	0.05	0.46	1.11	0.05	0.10	2.73	1.86	1.57
16	0.04	0.38	1.12	0.07	0.16	3.21	2.01	1.48
17	0.04	0.38	1.17	0.06	0.17	3.30	1.86	1.40
18	0.04	0.41	1.25	0.07	0.00	3.11	1.91	1.70
20	0.04	0.42	1.23	0.05	0.17	2.78	1.92	2.30

Concentration in mg of compound per gram of seed meal. No flavonolignan concentrations were significant using simple linear regression at $P < 0.05$.

Table B-10: Elemental content of fertilizer concentrate (mg/L) used to fertigate milk thistle (*Silybum marianum*) in a hydroponic experiment with different water rates.

Elements	PPM
Total N	10187.147
Ammonia N	675.559
Phosphorus	4085.55
Potassium	16407.418
Calcium	9663.236
Magnesium	5253.177
Sulfur	6592.815
Iron	208.037
Manganese	104.021
Zinc	25.994
Boron	104.021
Copper	25.99
Molybdenum	5.201
Chlorine	1040.215

Table B-11: Six yield parameters of milk thistle (*Silybum marianum*) at different daily water rates.

Treatment (mL/day)	Mature Seed Count	Immature Seed Count	Total Seed Count	Mature Seed Weight (g)	Immature Seed Weight (g)	Total Seed Weight (g)
200	274 ± 88	67 ± 49 AB ¹	341 ± 131	5.896 ± 2.358	0.241 ± 0.191	6.137 ± 2.537
650	305 ± 197	62 ± 51 B	367 ± 205	7.104 ± 4.985	0.171 ± 0.207	7.275 ± 5.007
1100	657 ± 348	102 ± 73 AB	758 ± 411	15.911 ± 9.989	0.392 ± 0.353	16.303 ± 10.224
1550	643 ± 366	64 ± 37 B	708 ± 381	15.934 ± 9.969	0.241 ± 0.220	16.175 ± 10.038
2000	624 ± 568	161 ± 153 A	785 ± 681	15.527 ± 15.478	0.433 ± 0.373	15.960 ± 15.663

LSD means separation shown (P<0.05). All other parameters were not significant at P<0.05.

Table B-12: Growth data of milk thistle (*Silybum marianum*) at different daily water rates.

Treatment (mL/day)	Number of Blooms per Plant	Bloom Diameter (cm)	Stem Height (cm)	Days to Maturity
200	4 ± 3	2.3 ± 0.4 B ¹	40.8 ± 11.0 C	289 ± 30
650	4 ± 2	2.5 ± 0.5 AB	68.8 ± 23.1 B	301 ± 12
1100	7 ± 4	2.9 ± 0.5 A	104.2 ± 24.7 A	307 ± 10
1550	6 ± 3	2.8 ± 0.4 AB	106.2 ± 18.9 A	301 ± 15
2000	6 ± 4	2.7 ± 0.6 AB	74.3 ± 24.3 B	296 ± 25

LSD means separation shown (P<0.05). All other parameters were not significant at P<0.05.

Appendix C: Chromatographs and DAD Spectra

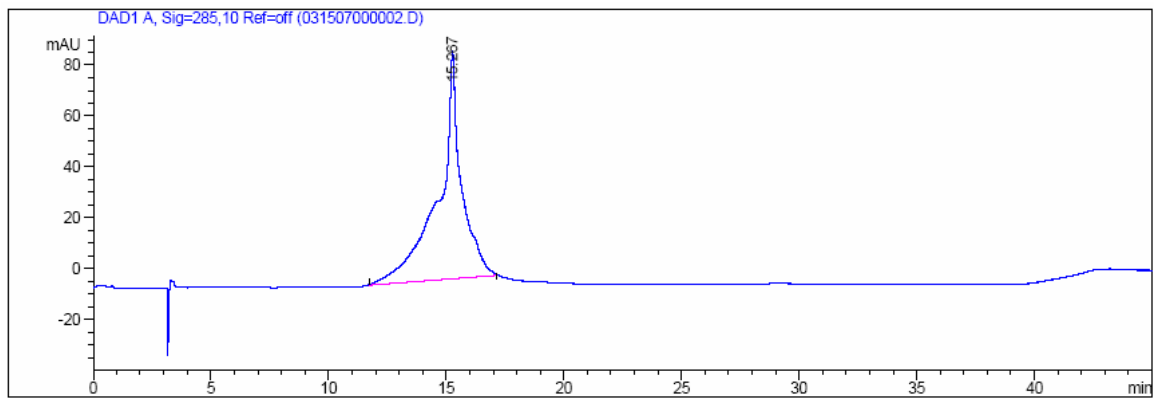

Figure C-29: Chromatogram of taxifolin standard

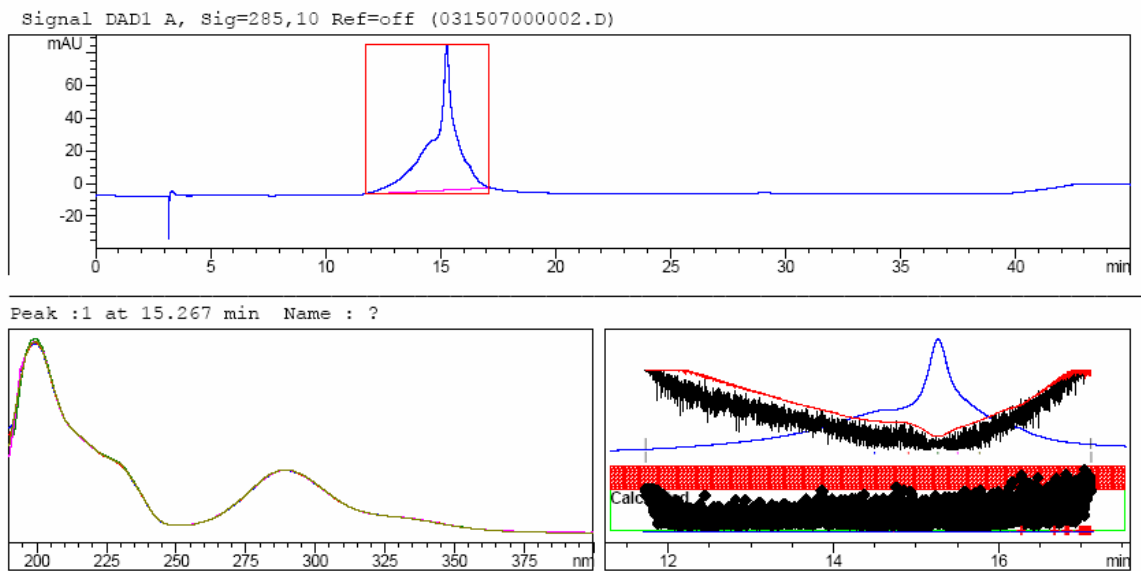
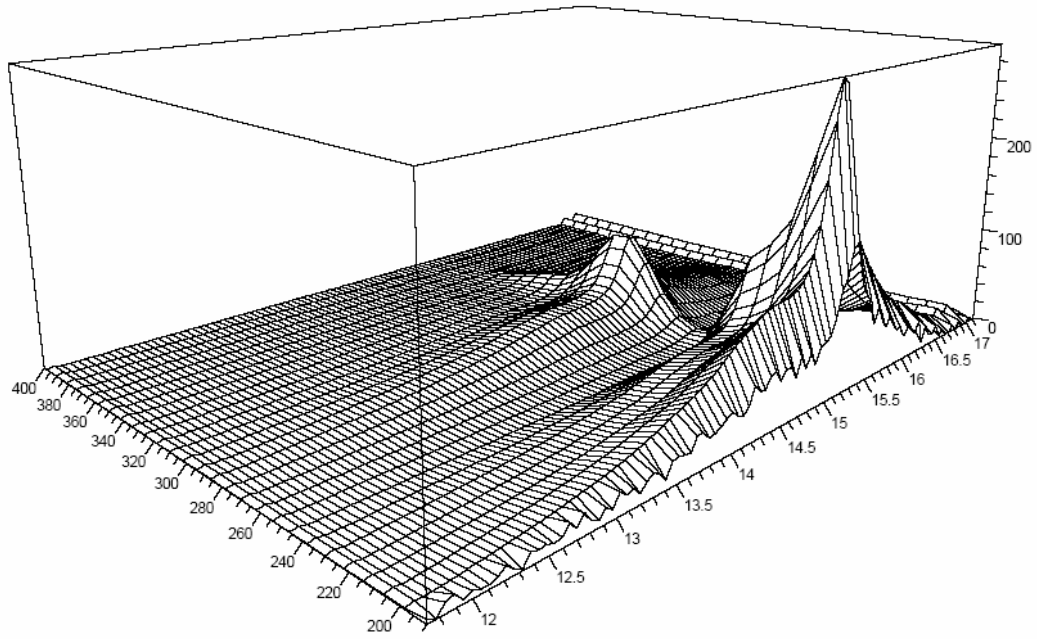

Figure C-30: Spectra for taxifolin standard



Datafile:	Sample name:
Tilt: 15.0 °, Swivel: 45.0 °	
Ranges: 11.7 to 17.1 , 190.0 to 400.0 , 0.0 to 297.0	

Figure C-31: 3-D spectra of taxifolin standard

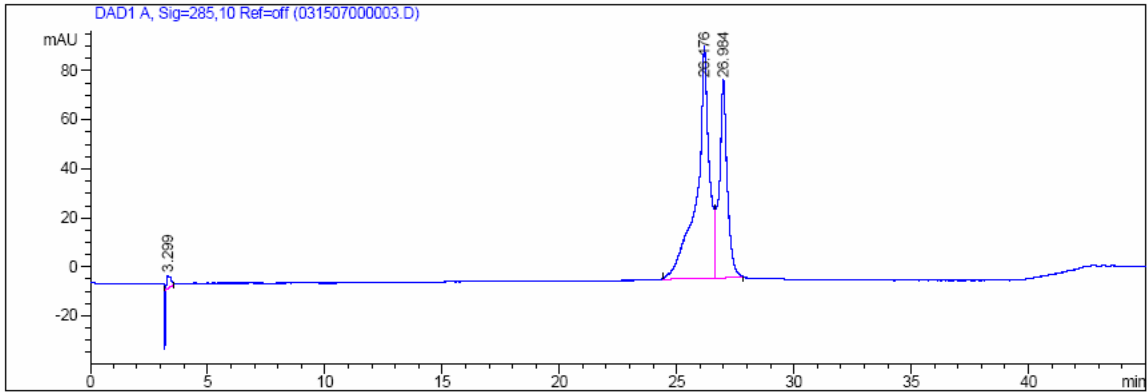

Figure C-32: Chromatogram of silybin standard (with silybin A and B)

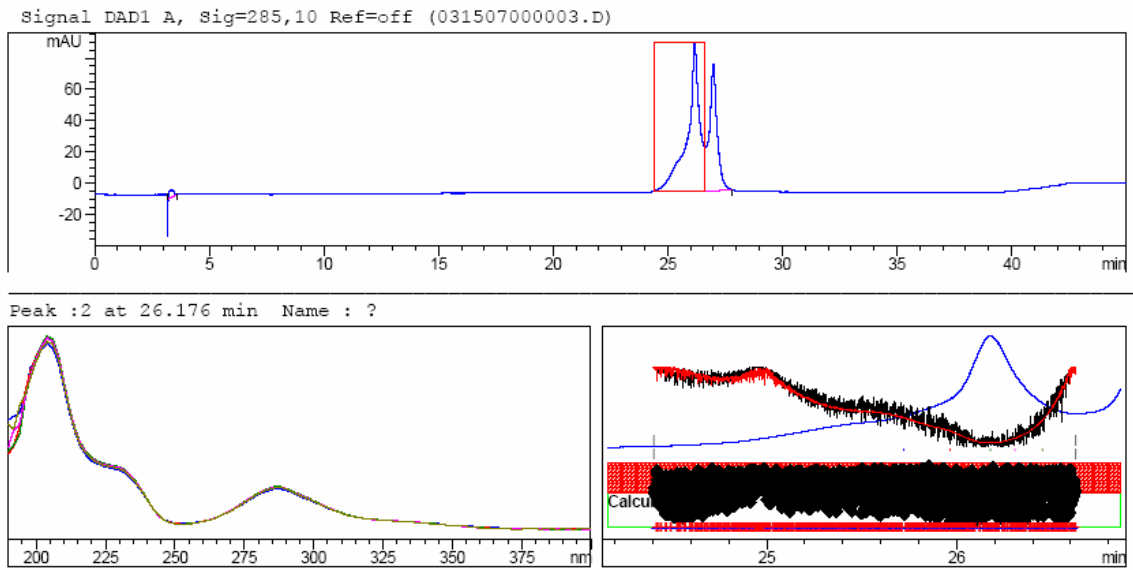

Figure C-33: Spectra for silybin A

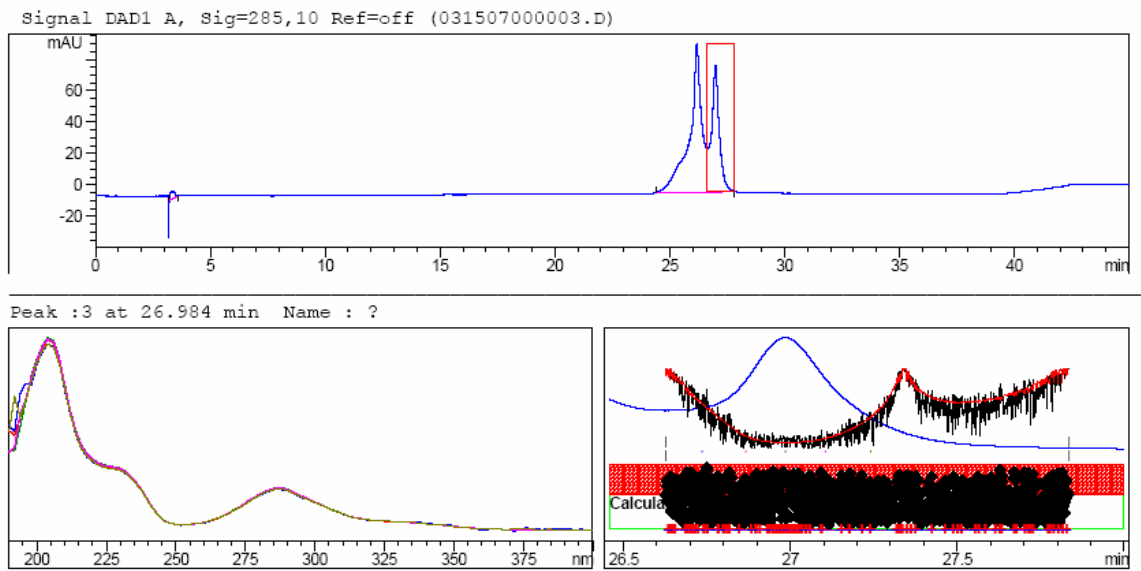
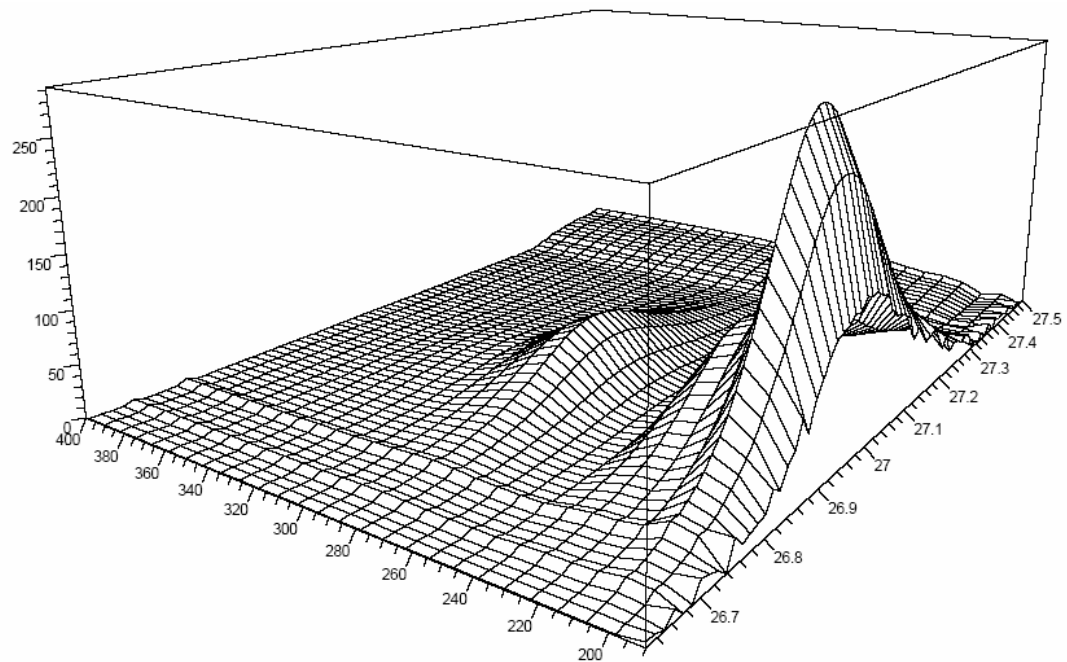
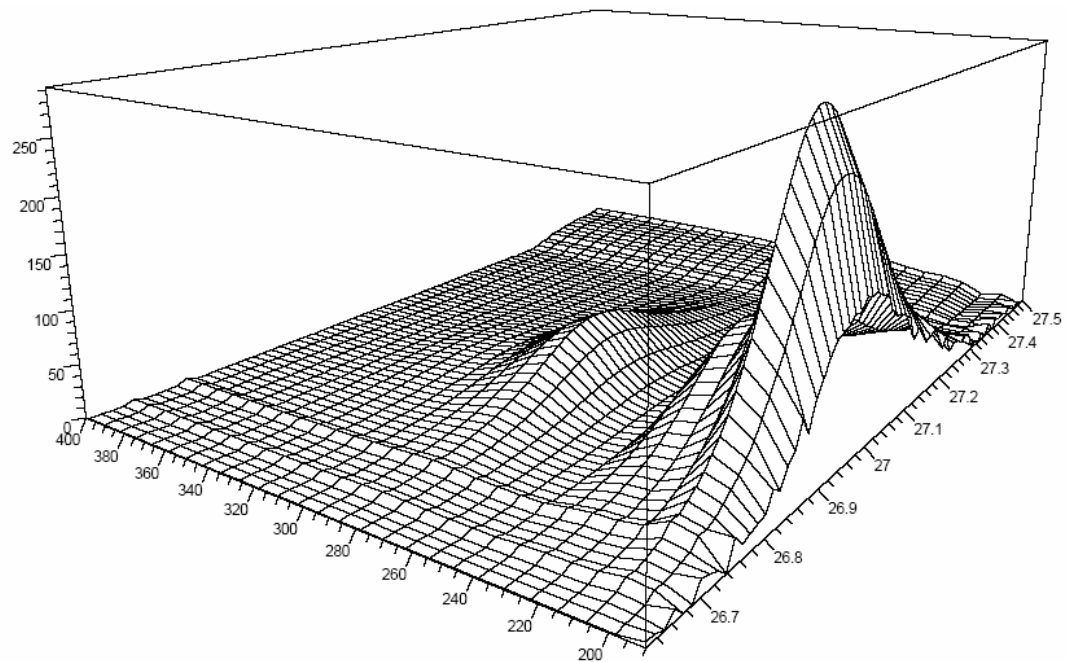

Figure C-34: Spectra for silybin B



Datafile:	Sample name:
Tilt: 15.0°, Swivel: 55.5°	
Ranges: 26.6 to 27.5, 190.0 to 400.0, 0.0 to 292.1	

Figure C-35: 3-D spectra of silybin A



Datafile:	Sample name:
Tilt: 15.0°, Swivel: 55.5°	
Ranges: 26.6 to 27.5, 190.0 to 400.0, 0.0 to 292.1	

Figure C-36: 3-D spectra of silybin B

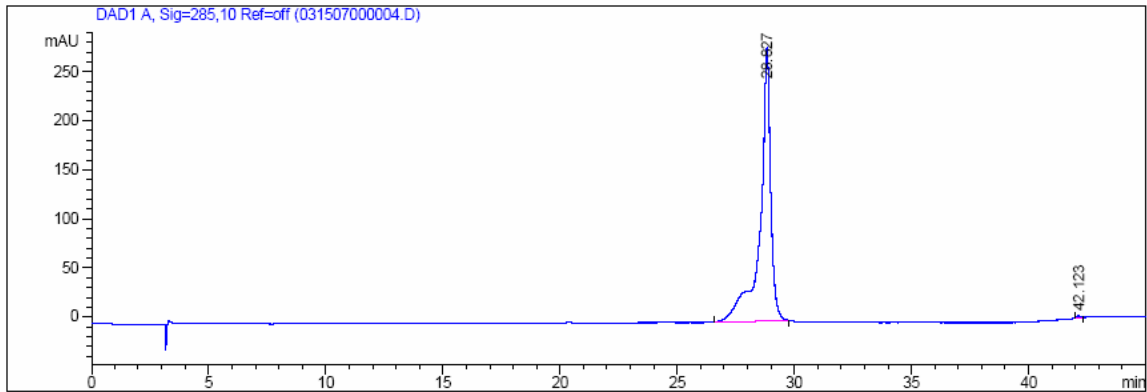

Figure C-37: Chromatogram of hesperetin (internal standard)

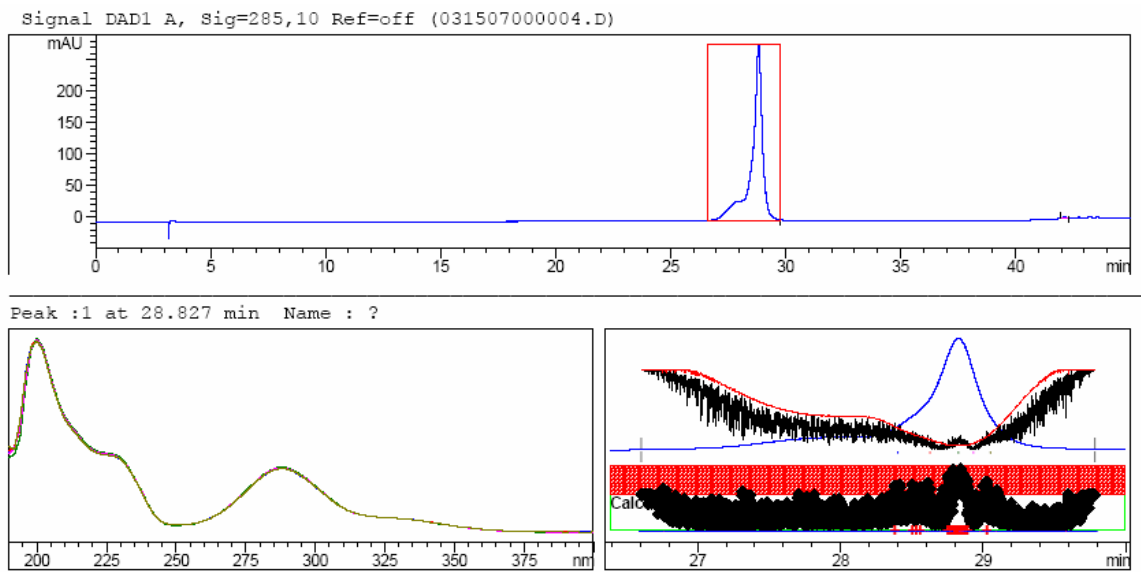
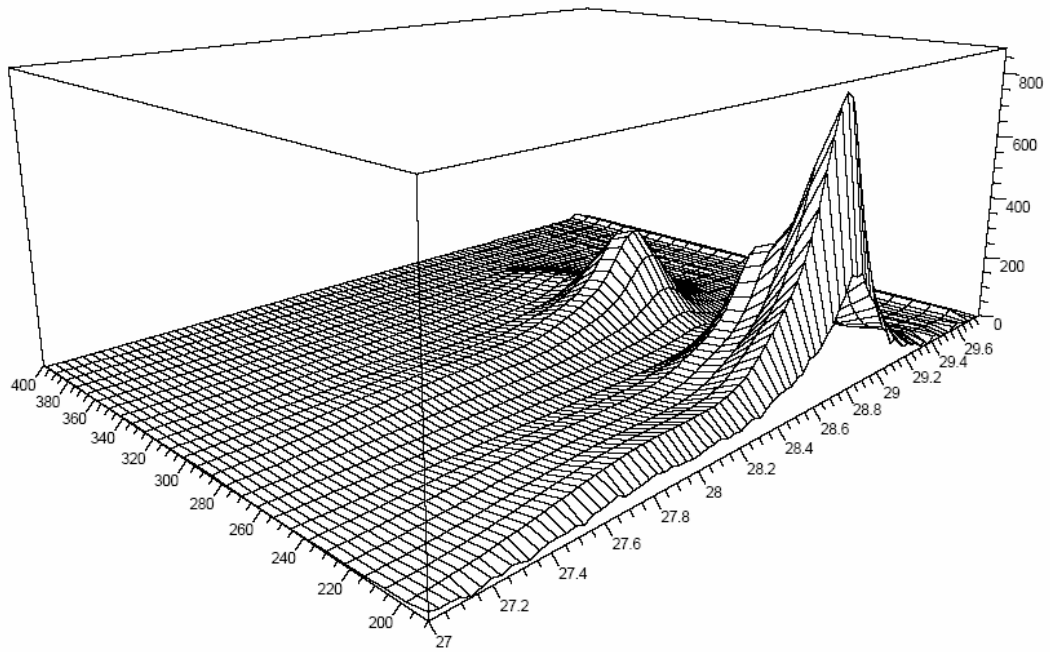

Figure C-38: Spectra for hesperetin



Datafile: Sample name:
Tilt: 15.0°, Swivel: 45.0°
Ranges: 27.0 to 29.8, 190.0 to 400.0, 0.0 to 878.3

Figure C-39: 3-D spectra of hesperetin

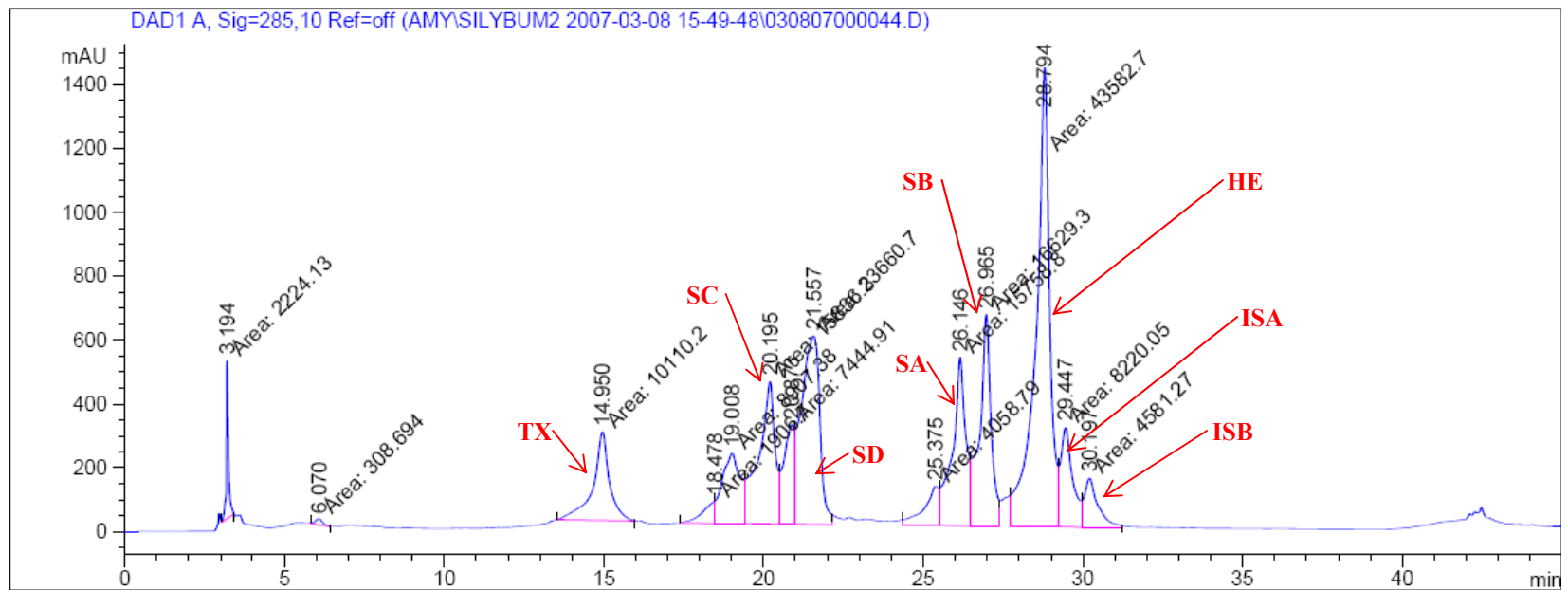

Figure C-40: HPLC chromatograph of silymarin profile of milk thistle (*Silybum marianum*) grown at a density of two plants per container. TX=taxifolin; SC=silychristin; SD=silydianin; SA=silybin A; SB=silybin B; HE=hesperetin; ISA=isosilybin A; ISB=isosilybin B.

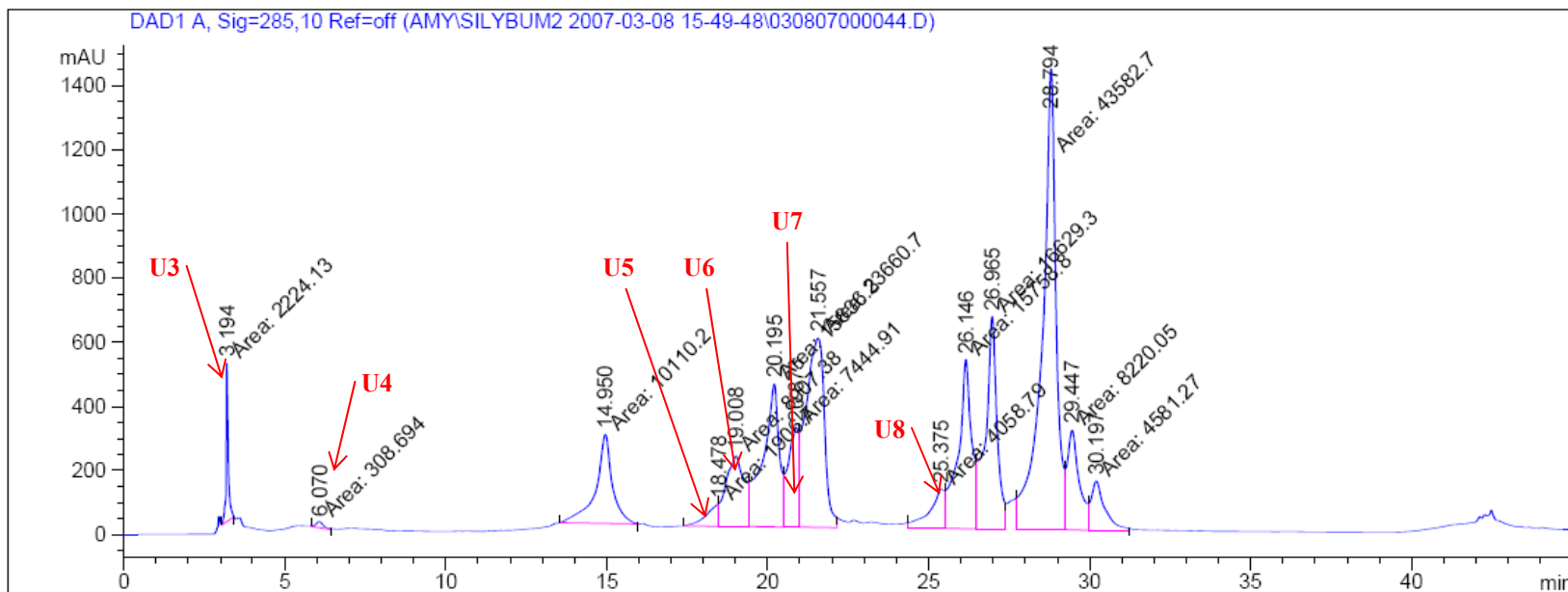

Figure C-41: HPLC chromatograph of unknown compounds in milk thistle (*Silybum marianum*) seeds grown at a density of two plants per container. U3=unknown 3; U4=unknown 4; U5=unknown 5; U6=unknown 6; U7=unknown 7; U8=unknown 8.

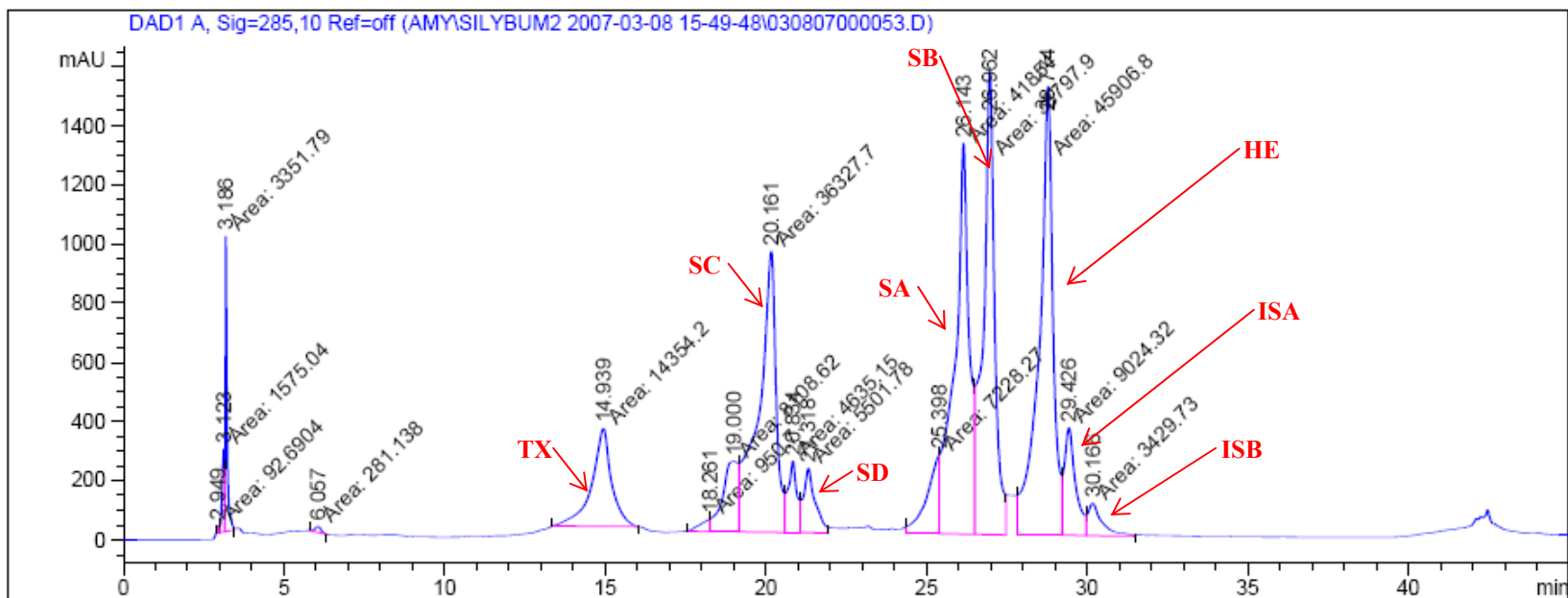

Figure C-42: HPLC chromatograph of silymarin profile of milk thistle (*Silybum marianum*) grown at a density of four plants per container. TX=taxifolin; SC=silychristin; SD=silydianin; SA=silybin A; SB=silybin B; HE=hesperetin; ISA=isosilybin A; ISB=isosilybin B.

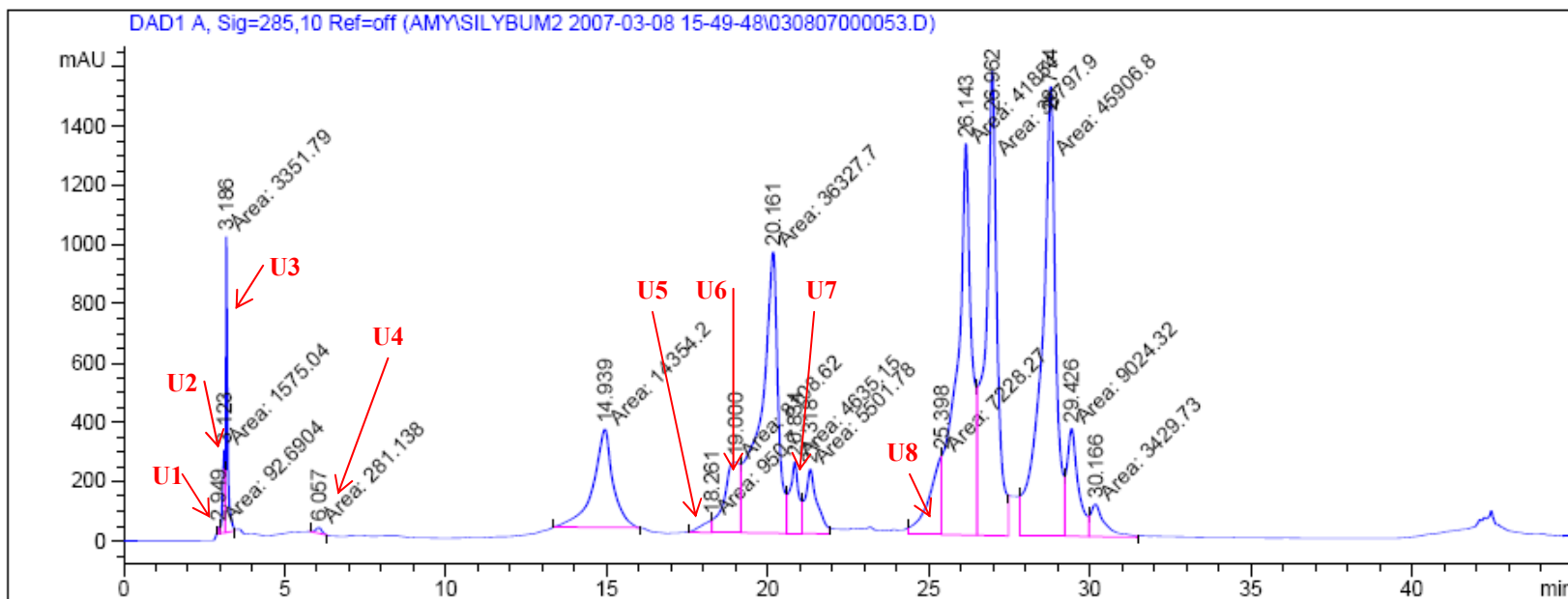

Figure C-43: HPLC chromatograph of unknown compounds in milk thistle (*Silybum marianum*) seeds grown at a density of four plants per container. U1= unknown 1; U2=unknown 2; U3=unknown 3; U4=unknown 4; U5=unknown 5; U6=unknown 6; U7=unknown 7; U8=unknown 8.

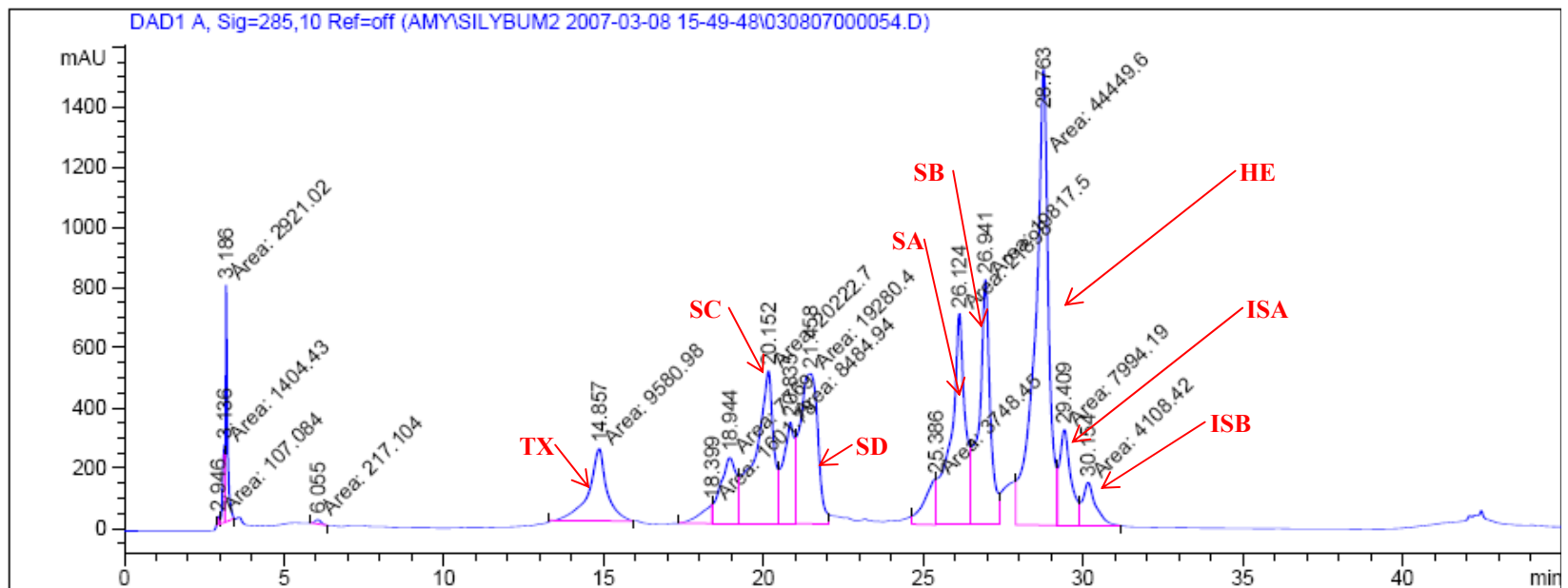

Figure C-44: HPLC chromatograph of silymarin profile of milk thistle (*Silybum marianum*) grown at a density of eight plants per container. TX=taxifolin; SC=silychristin; SD=silydianin; SA=silybin A; SB=silybin B; HE=hesperetin; ISA=isosilybin A; ISB=isosilybin B.

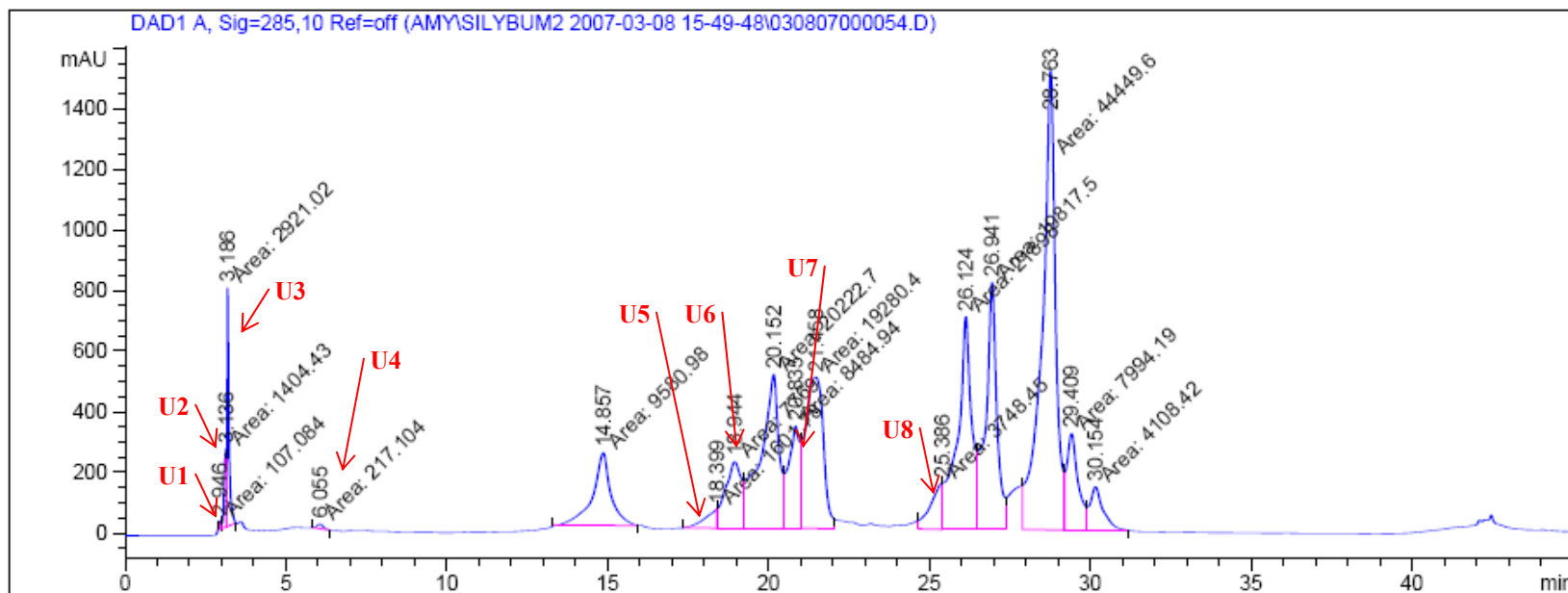

Figure C-45: HPLC chromatograph of unknown compounds in milk thistle (*Silybum marianum*) seeds grown at a density of eight plants per container. U1= unknown 1; U2=unknown 2; U3=unknown 3; U4=unknown 4; U5=unknown 5; U6=unknown 6; U7=unknown 7; U8=unknown 8.

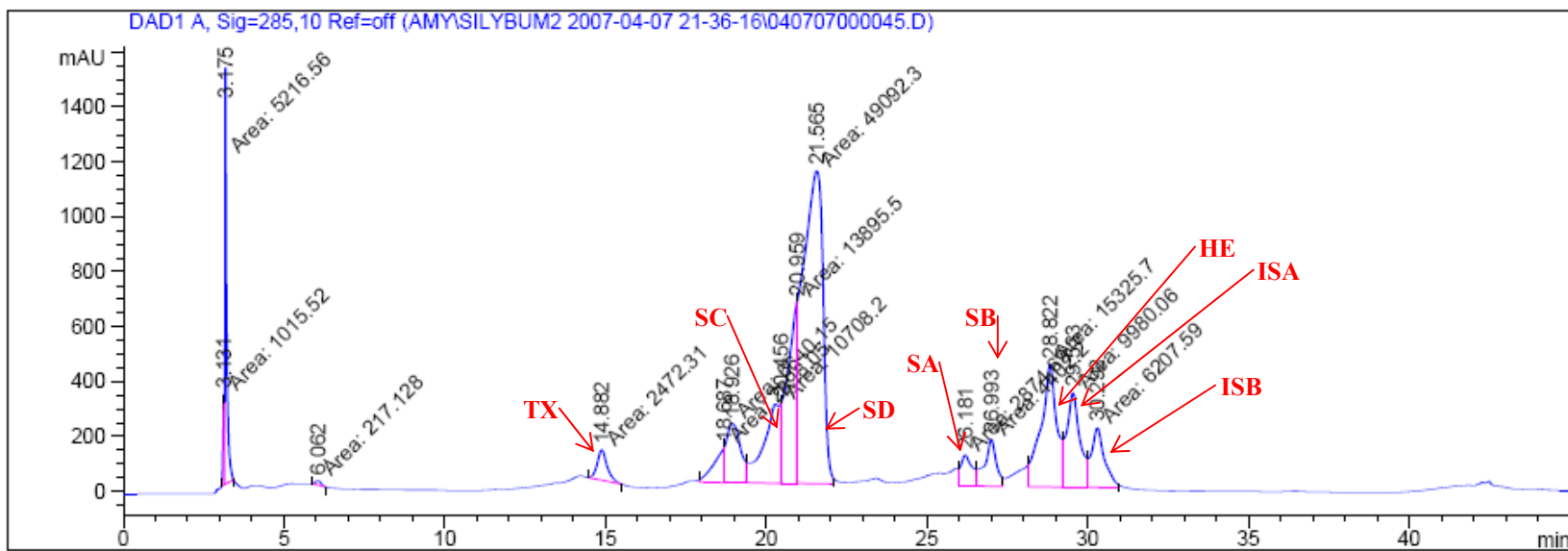

Figure C-46: HPLC chromatograph of silymarin profile the secondary blooms of a milk thistle (*Silybum marianum*) plant grown at water rate of 2000 mL/day. TX=taxifolin; SC=silychristin; SD=silydianin; SA=silybin A; SB=silybin B; HE=hesperetin; ISA=isosilybin A; ISB=isosilybin B.

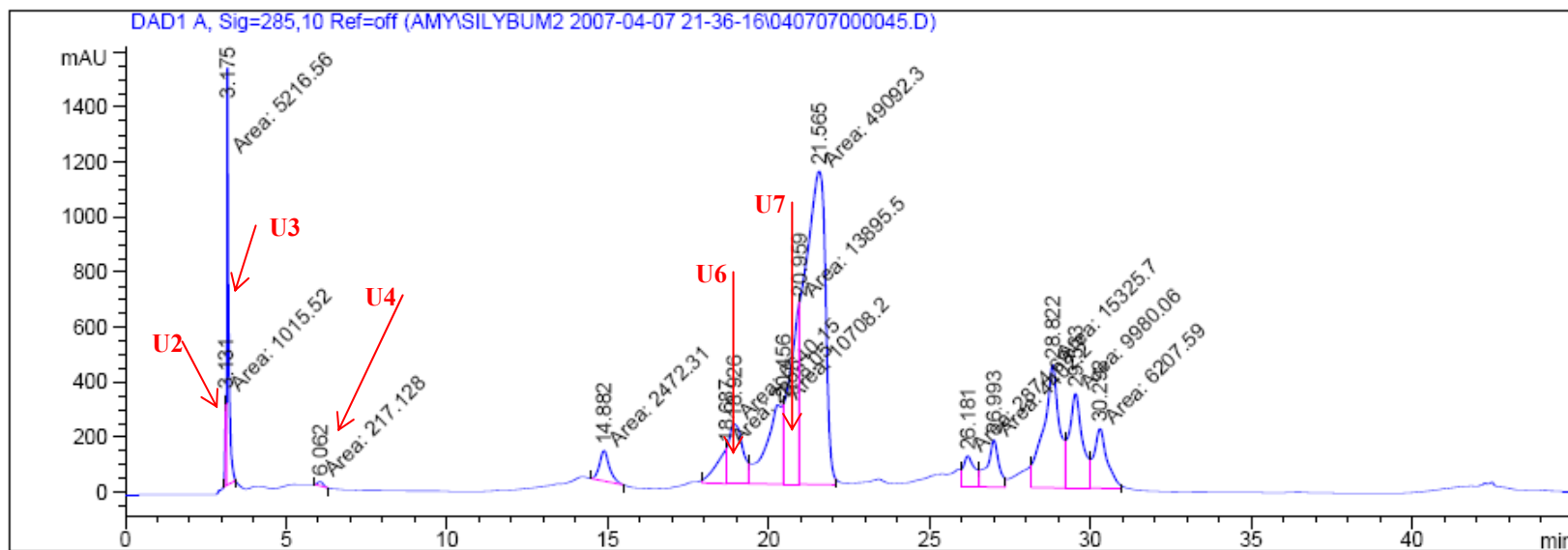

Figure C-47: HPLC chromatograph of unknown compounds in seeds from secondary blooms of a milk thistle (*Silybum marianum*) plant grown at water rate of 2000 mL/day. U2=unknown 2; U3=unknown 3; U4=unknown 4; U6=unknown 6; U7=unknown 7.

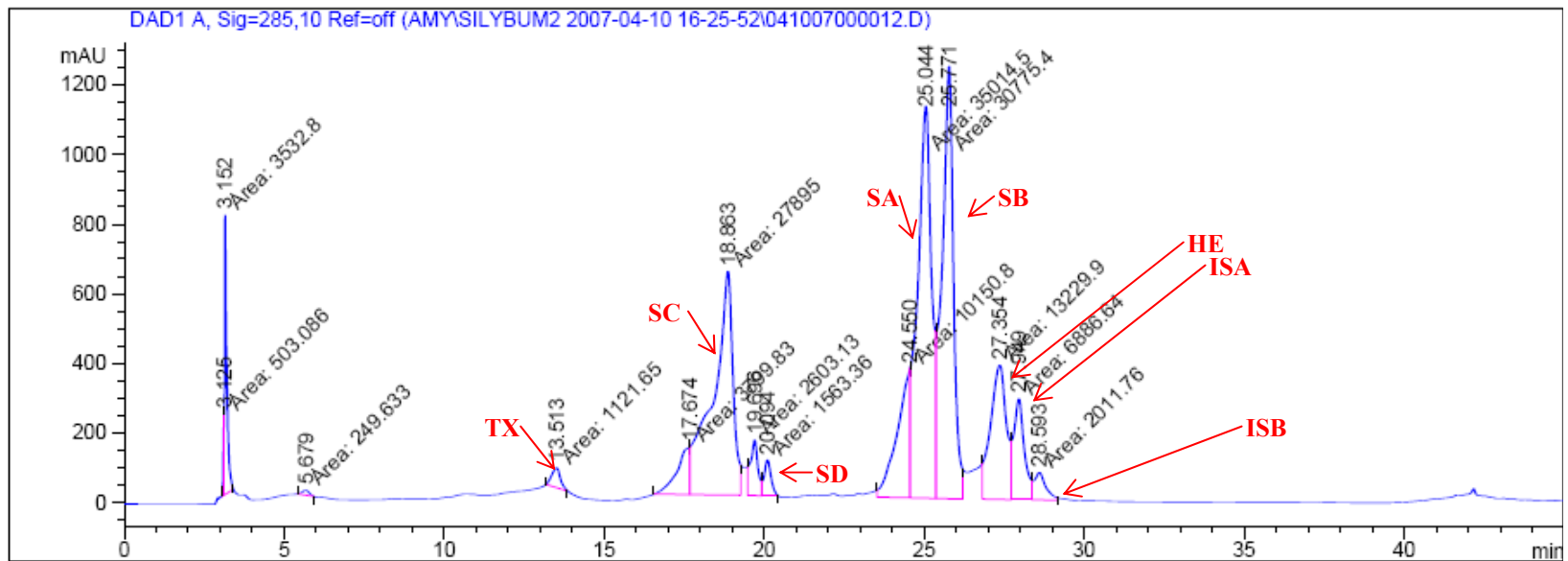

Figure C-48: HPLC chromatograph of silymarin profile the secondary blooms of a milk thistle (*Silybum marianum*) plant grown at water rate of 650 mL/day. TX=taxifolin; SC=silychristin; SD=silydianin; SA=silybin A; SB=silybin B; HE=hesperetin; ISA=isosilybin A; ISB=isosilybin B.

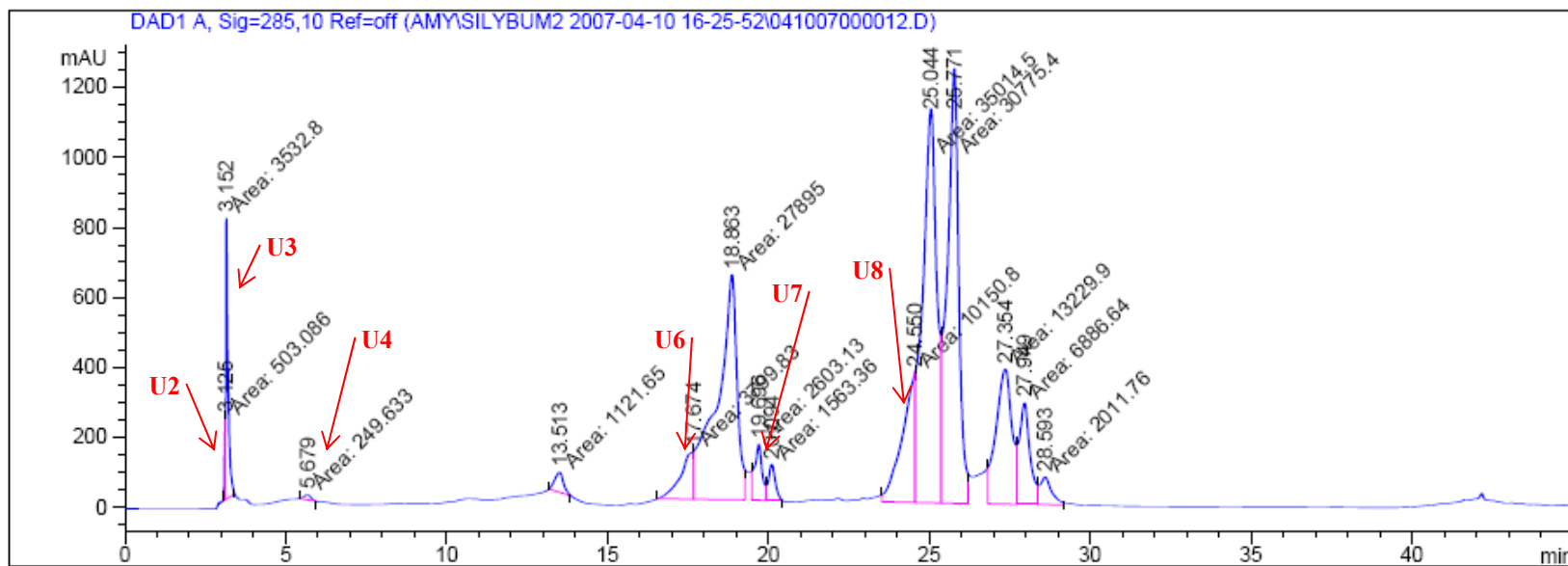

Figure C-49: HPLC chromatograph of unknown compounds in seeds from secondary blooms of milk thistle (*Silybum marianum*) grown at water rate of 650 mL/day. U2=unknown 2; U3=unknown 3; U4=unknown 4; U6=unknown 6; U7=unknown 7; U8=unknown 8.

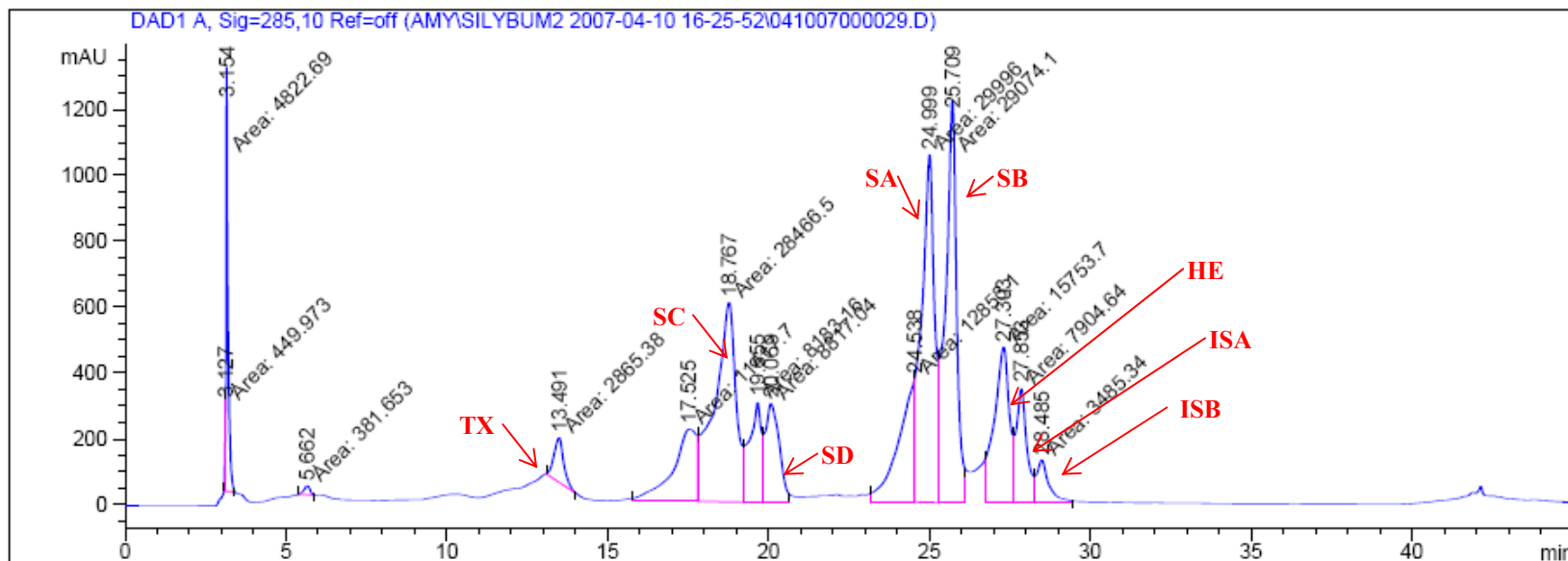

Figure C-50: HPLC chromatograph of silymarin profile of milk thistle (*Silybum marianum*) seeds from Frontier Natural Products Co-op. TX=taxifolin; SC=silychristin; SD=silydianin; SA=silybin A; SB=silybin B; HE=hesperetin; ISA=isosilybin A; ISB=isosilybin B.

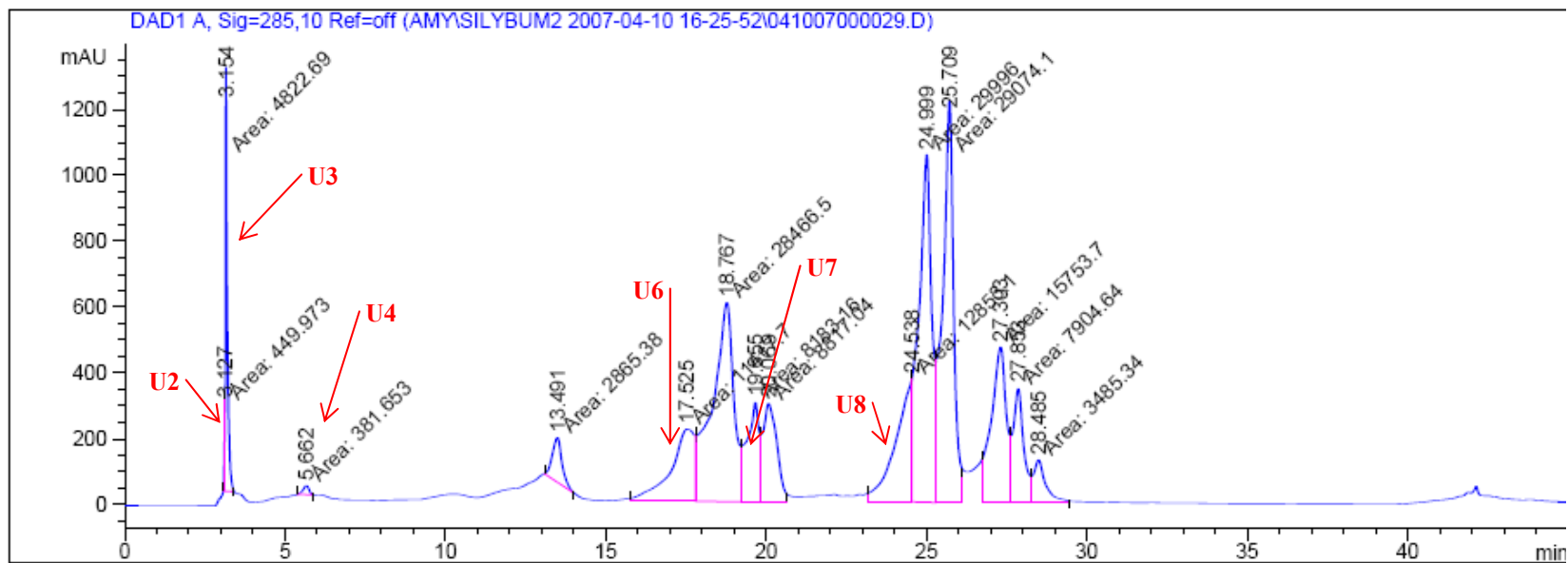

Figure C-51: HPLC chromatograph of unknown compounds in milk thistle (*Silybum marianum*) seeds from Frontier Natural Products Co-op. U2=unknown 2; U3=unknown 3; U4=unknown 4; U6=unknown 6; U7=unknown 7; U8=unknown 8.

Appendix D: Procedures

Procedure D-1: Seed Sterilization Procedure

1. Cheese cloth squares (approximately 6 cm x 6 cm) were cut to hold seeds in during sterilization treatments. Squares were wrapped around seeds and secured with a rubber band.
2. Groups of seeds were placed in beakers and covered with a 70% ethanol solution and placed on a shaker for 2 minutes.
3. After 2 minutes, ethanol was poured off and seeds were washed with water three times.
4. Seeds were placed back into rinsed beakers and covered with a 5% bleach solution, containing 1% sodium dodecyl sulfate (SDS) by weight. These were placed on the shaker for 15 minutes.
5. After 15 minutes, the bleach solution was poured off and seeds were rinsed thoroughly with water.
6. Seeds were then laid out on paper towels to dry if in preparation for HPLC analysis. If seeds were sterilized in preparation to be germinated for an experiment, seeds were then placed in a beaker of hot water for 12-16 hours for imbibition preceding germination.

Procedure D-2: Flavonolignan Extraction from *Silybum marianum* for HPLC

Analysis

Procedure modified from Wallace, S., D.J. Carrier, R.R. Beitle, E.C. Clausen and C.L.

Griffis. 2003. J Nutraceut Function Med Foods. 4(2): 37-48.

1. Grind seeds in coffee mill to 20 mesh.
2. Weigh 100 mg ground seed sample into 1.5 mL amber microcentrifuge tube.
3. Add 0.5 mL (5:1, solvent: sample) petroleum ether to microcentrifuge tube.
4. Vortex.
5. Sonicate for 30 minutes.
6. Vortex.
7. Centrifuge for 10 minutes at 2000 RCF.
8. Decant supernatant.
9. Add 0.5 mL methanol to microcentrifuge tube.
10. Vortex.
11. Sonicate for 20 minutes.
12. Vortex.
13. Centrifuge for 10 minutes at 2000 RCF.
14. Decant supernatant into 15 mL test tube and cap. Protect collected supernatant from light.
15. Repeat steps 9-15 three times.
16. Evaporate collected supernatant to dryness under N₂ stream.

17. Add 1mL methanol.

18. Add 100 μ L of hesperetin internal standard (1.0 mg/mL stock solution)

19. Vortex.

Filter through 0.45 μ m syringe filter into amber crimp-top HPLC sample vials.

Procedure D-3: HPLC Parameters

HPLC:

Agilent 1100 (Agilent Technologies, Santa Clara, CA)

Detector:

Diode array detector (DAD) with 3-D spectra

Column:

Luna C-18(2) (250 x 4.6 mm, 5 μ m) (Phenomenex, Torrance, CA)

Column temperature:

40 C

Mobile phases:

A: 20:80 methanol: water

B: 80:20 methanol: water

Flow rate:

0.8 mL/min

Injection volume:

25 μ L

Solvent gradient:

Time (min)	Solvent A (CH ₃ OH:H ₂ O)	Solvent B (CH ₃ OH:H ₂ O)
0	85	15
5	85	15
20	45	55
35	45	55
38	0	100
43	0	100
44	85	15

Procedure D-4: Determination of Flavonolignan Concentration in *Silybum*

***marianum* seeds from HPLC Analysis Data**

Flavonolignan concentrations were determined using an internal standard method. The internal standard (IS) used was hesperetin, a flavonoid common in citrus. Each sample had 100 μ L of 1.0 mg/mL hesperetin stock solution added before HPLC analysis. The concentration (conc) of hesperetin standard in each sample was 0.091 mg/mL. After each run, the peak areas from the sample were used to find concentration of individual flavonolignans (flav). The following formula was used to relate flavonolignan peak area, IS peak area, and sample weight into flavonolignan concentration:

$$conc = (flav\ peak\ area/IS\ area) * RF * (1000/sample\ weight)$$

RF is the retention factor of each flavonolignan compound to compensate for variation in DAD detection between the internal standard and flavonolignan compounds. This was determined for the silybin A & B standard and the taxifolin standard. All other flavonolignans were calculated using the RF from taxifolin.

$$(flav\ standard\ conc)/(flav\ peak\ area) * RF = (IS\ conc)/(IS\ peak\ area)$$

Individual flavonolignan identification was accomplished by comparing sample peak retention times to retention times of pure standards. Pure standards used were taxifolin, silybin A & B, silydianin, and a silymarin mixture. Taxifolin, silybin, and silymarin standards were obtained from Sigma-Aldrich (St. Louis, MO). Silydianin was obtained from ChromaDex (Irvine, CA). Previously published chromatographs also assisted in conformation. (Wallace et al., 2003)

Peak areas were established using manual, base-line integration. 3-D spectra of standards and samples assisted in determining peak separation.

Procedure D-5: Hesperetin Internal Standard Preparation

These various concentrations of the internal standard were run when deciding how much of the internal standard should be added to each sample. The peak size of the internal standard should be on a similar scale as the peak sizes of the compounds of interest. For flavonolignan analysis, 100 μL of 1.0 mg/mL hesperetin stock solution was added to each milk thistle seed sample for an internal standard concentration of 0.091 mg/mL in each sample.

1 $\mu\text{g}/\mu\text{L}$ to 0.01 $\mu\text{g}/\mu\text{L}$ (from Wallace et al. 2003)

1.0 mg/mL
0.5 mg/mL
0.1 mg/mL
0.05 mg/mL
0.01 mg/mL

1.0 mg/mL

Weigh 10mg hesperetin into 10mL volumetric flask.
Add ~ 5mL deionized (di) water.
Sonicate to dissolve any solids.
Fill to line.

0.5 mg/mL

Pipette 1mL of 1.0mg/mL solution into clean glass vial. Add 4mL di water

0.1 mg/mL

Pipette 1mL of 0.5mg/mL solution into clean glass vial. Add 4mL di water

0.05 mg/mL

Pipette 1mL of 0.1mg/mL solution into clean glass vial. Add 4mL di water

0.01 mg/mL

Pipette 1mL of 0.05mg/mL solution into clean glass vial. Add 4mL di water

Vita

Amy Renae Belitz was born in Knoxville, TN, on February 17, 1982. She has lived in Maryville and Louisville, TN. After graduating from William Blount High School in 1999, she came to The University of Tennessee, Knoxville, and graduated Summa Cum Laude with a B.S. Ornamental Horticulture and Landscape Design and a minor in botany in 2003. After graduation, Amy started a Masters of Science program in Plant Sciences at UTK to study crop physiology and medicinal plants. She graduated in August 2007.

Amy intends on pursuing herbalism and horticulture to teach and work in a professional setting.

